

Versatility for Rear Lighting

LUXEON Versat Portfolio Extension



The LUXEON Versat portfolio, featuring a variety of flux levels and colors in two different package sizes, offers a wide range of styling options for rear-combination lamp design. New portfolio extensions for high-brightness phosphor-converted red, amber, and green enable increased styling flexibility by eliminating the need for clear or amber cover glass. The compact package is also perfect for simple custom displays.

FEATURES AND BENEFITS

- Wide range of color proliferations and flux levels to cover the full range of rear-lighting functionality: direct-color (red and amber) and phosphor-converted (red, amber, green, and white) LEDs
 - The LUXEON Versat family features flat LED packages with good thermal properties for thin, compact, and space-saving luminaires
 - Lumileds also offers design-in support to predict the light output and color of LUXEON Versat with cover lenses over the full parameter space of temperature and drive current
-

PRIMARY APPLICATIONS

- Full rear-combination lamp functionality: position, stop, and turn
 - Backup
 - Rear fog
 - Communication display
-

Versatility for Rear-Lighting Applications

1 High-Brightness Turn Signal for Smoked Cover-Lens Design

LUXEON Versat PC Amber provides the **highest flux output** at elevated operating temperatures due to its **increased hot/cold factor** versus to direct amber LEDs, enabling more design freedom.

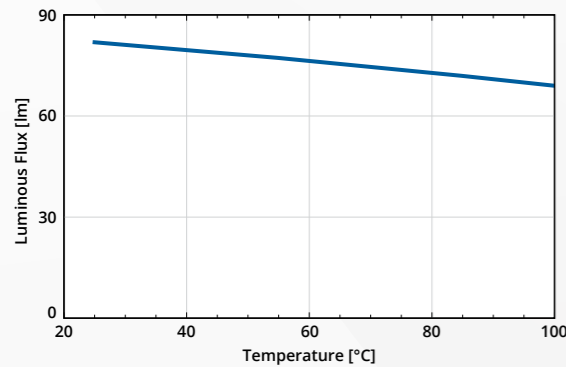

Luminous flux as a function of operating temperature for LUXEON Versat 3030 PCA at 350 mA

3 Distinctive Reds

The LUXEON Versat Red portfolio offers four red color options: **Red Orange**, **Red**, **Long Red**, and **Super Red**, providing distinctive lit appearances.

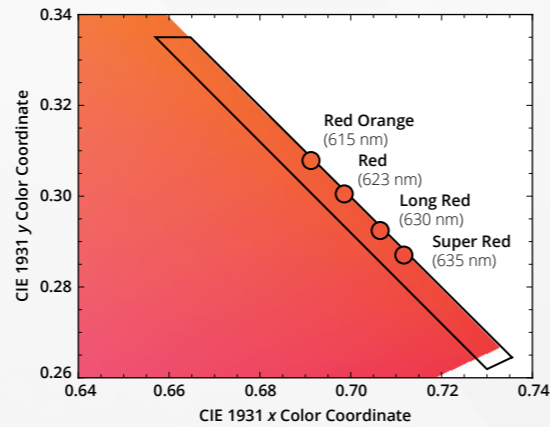

Red color bins of LUXEON Versat 2020 operated at 55 °C and 75 mA

2 Amber Turn through Red Cover

LUXEON Versat Amber Bin 0 offers **unique design options with colored cover lenses**. Best design options exist for rose-red materials, e.g. Plexiglas® 8N 3V124. Real red materials like Plexiglas® 8N 33691 can also be used at controlled temperature conditions.

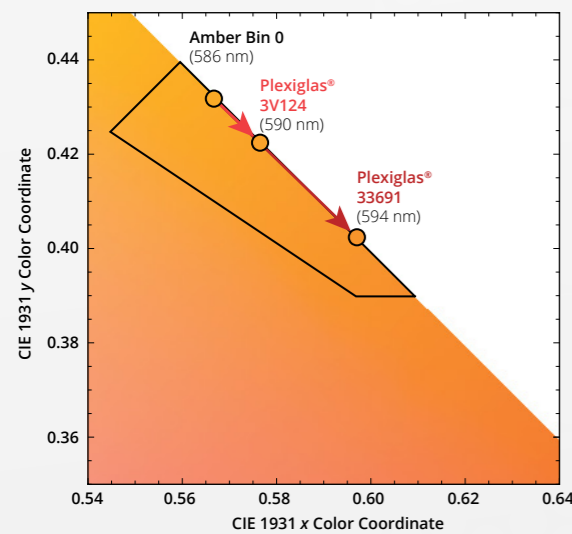

Color shift with 2.5 mm cover Plexiglas® 8N red 3V124 and Plexiglas® 8N red 33691 for LUXEON Versat 2020 Amber Bin 0 operated at 55 °C and 140 mA

4 Signature and Communication Display

LUXEON Versat 2020: **Small footprint, precise LED package**

- Small 2.0 mm × 2.0 mm footprint
- Low height of 0.7 mm
- Excellent part tolerances of 0.1 mm
- Excellent placement accuracy enabling precise matching of reflector to LED

Demonstrator architecture

- Efficient coupling with the reflector's small inlet opening
- Performant optical systems from simple-to-build parts
- FR4 board leaves ample room for routing and mechanical references
- Driving electronics on the rear of the board are designed with released standard automotive components

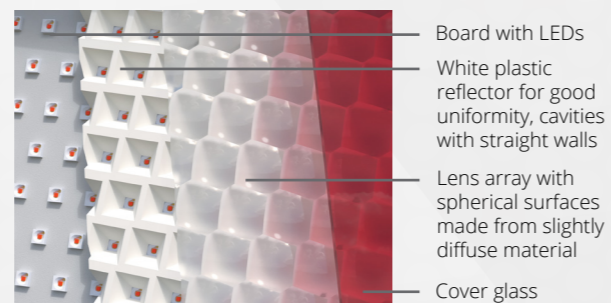

Display system

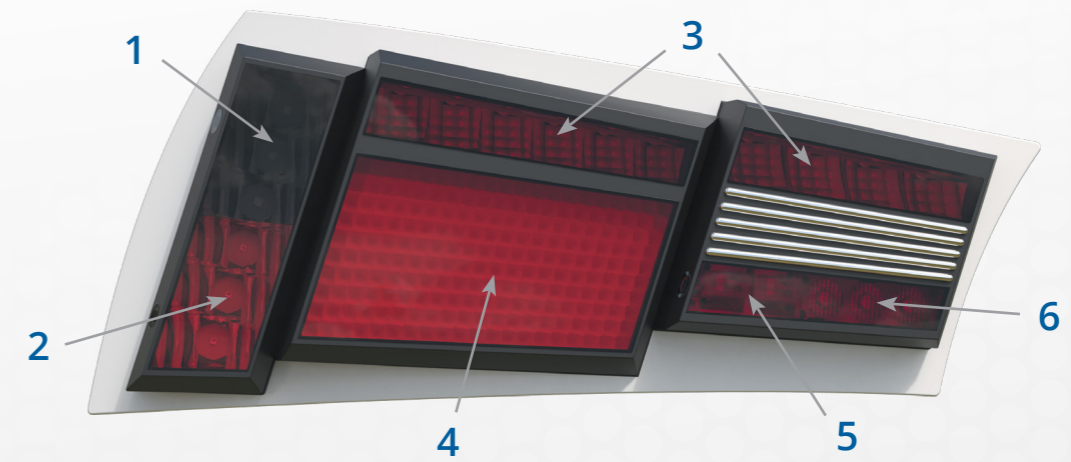

5 Phosphor-Converted Red for Rear Fog

LUXEON Versat PC Red provides a high flux output at elevated temperatures. The **excellent hot-cold factor**, even at high drive conditions, greatly simplifies compact optical design, achieving compliant photometrics (e.g. for rear-fog applications).

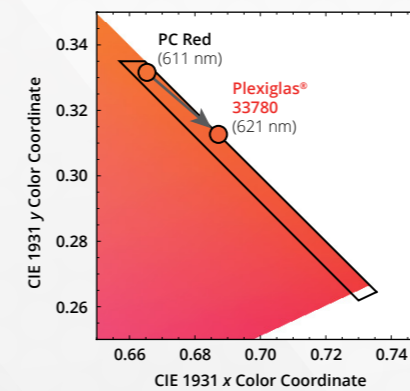

Color shift with 2.5 mm cover Plexiglas® 8N red 33780 for LUXEON Versat 3030 PC Red operated at 85°C and 500 mA

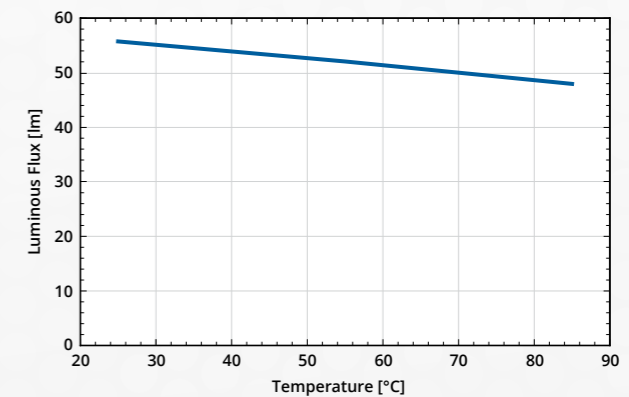

Luminous flux as a function of operating temperature for LUXEON Versat 3030 PC Red at 500 mA

6 White Backup Light through Rose-Red Colored Cover Lens

LUXEON Versat PC Green provides a more **consistent styling appearance** by eliminating the need for a clear lens. White light is being created by a combination of a rose-red cover and a phosphor-converted green LED. Matching materials are available from several suppliers.

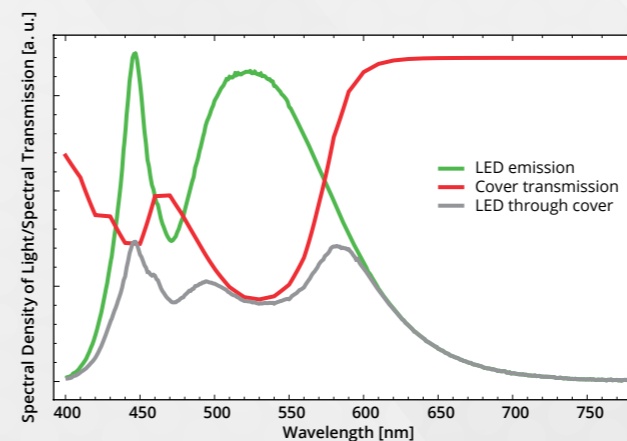



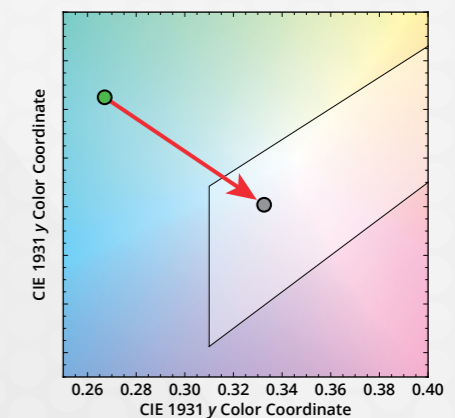



Spectral characteristics of LED, cover glass, and combination (white backup light)









Color shift with 2.5 mm cover Plexiglas® 8N red 3V124 for LUXEON Versat 3030 PC Green

LUXEON Versat 2020, 3030, and Dual Color

LUXEON Versat 2020 and 3030 will be available as a portfolio covering a wide range of colors and flux levels.

Typical Flux (25 °C, binning current)	Amber (Bin 0)	Amber (Bin 1)	Red Orange (Bin 3)	Red (Bin 6)	Long Red (Bin 4)	Super Red (Bin 5)
LUXEON Versat 2020 20 			3.1 lm	2.5 lm	1.8 lm	1.4 lm
LUXEON Versat 2020 50 	6.3 lm	6.8 lm	7.8 lm	6.1 lm	4.7 lm	3.5 lm
LUXEON Versat 2020 140 	17.7 lm	21.1 lm	24.2 lm	19.3 lm	14.5 lm	10.9 lm
LUXEON Versat 3030 ST 200 			38 lm	30.4 lm	22.8 lm	17.1 lm
LUXEON Versat 3030 ST 350 			65 lm	51 lm	40.4 lm	30.3 lm
LUXEON Versat 3030 ST 700 			140 lm	118 lm	88.6 lm In review	61 lm In review

Typical Flux (25 °C, binning current)	Cool White	PC Green	PC Amber	PC Red
LUXEON Versat 3030 HP 150 	53.7 lm		37.8 lm	
LUXEON Versat 3030 HP 350 	134 lm		87.7 lm	
LUXEON Versat 3030 ST 150 	57.9 lm		36.2 lm	
LUXEON Versat 3030 ST 350 	133 lm	> 120 lm	86 lm	> 40 lm Q2 2022
LUXEON Versat 2020 150 	55.5 lm		33.8 lm	
LUXEON Versat Dual Color 	60.1 lm		40.2 lm	

Mechanical Drawings

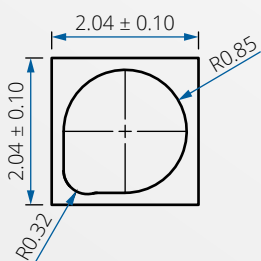

LUXEON Versat 2020 20/50/140

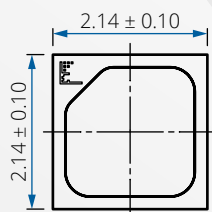

LUXEON Versat 2020 150

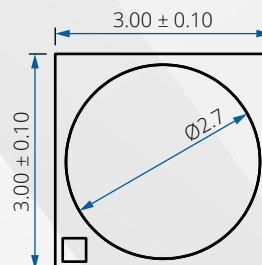

LUXEON Versat 3030 ST/HP

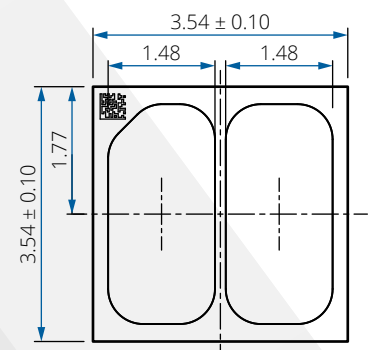

LUXEON Versat Dual Color

©2021 Lumileds Holding B.V. All rights reserved. LUXEON is a registered trademark of the Lumileds Holding B.V. in the United States and other countries.

lumileds.com

Neither Lumileds Holding B.V. nor its affiliates shall be liable for any kind of loss of data or any other damages, direct, indirect or consequential, resulting from the use of the provided information and data. Although Lumileds Holding B.V. and/or its affiliates have attempted to provide the most accurate information and data, the materials and services information and data are provided "as is," and neither Lumileds Holding B.V. nor its affiliates warrants or guarantees the contents and correctness of the provided information and data. Lumileds Holding B.V. and its affiliates reserve the right to make changes without notice. You as user agree to this disclaimer and user agreement with the download or use of the provided materials, information and data. A listing of Lumileds product/patent coverage may be accessed at lumileds.com/patents.