



SnapLED Xtreme

Homogeneity and reliability

SnapLED Xtreme, the newest addition to the SnapLED family, creates an effective homogeneous styling through its innovative and unique oval-batwing lens that provides even illumination over a wide rectangle.

SnapLED Xtreme is a proven LED that enables homogenous appearance with a minimum number of LEDs and reduced secondary optic requirements.

SnapLED Xtreme is available in the following colors:

- Super Red 635nm
- Red Orange 615nm



FEATURES AND BENEFITS

Unique Batwing lens to reduce LED count and secondary optic to enable homogeneous appearance

Low thermal resistance for better hot lumen performance

Higher drive current capability for increased flux performance

Highest maximum junction temperature for increased robustness of LED

PRIMARY APPLICATIONS

Stop/Tail

- CHMSL

Table of Contents

General Product Information	2
Product Test Conditions	2
Part Number Nomenclature	2
Environmental Compliance	2
Performance Characteristics	3
Product Selection Guide	3
Optical Characteristics	3
Electrical Characteristics	3
Absolute Ratings	4
Characteristic Curves	5
Spectral Power Distribution Characteristics	5
Light Output Characteristics	5
Forward Current Characteristics	6
Radiation Pattern Characteristics	7
Operating Limits Characteristics	8
Thermal Resistance	8
Product Bin and Labeling Definitions	9
Designing with SnapLED Xtreme	9
Decoding Product Bin Labeling	9
Luminous Flux Bins	9
Color Codes	10
Forward Voltage Bins	10
Mechanical Dimensions	11
Packaging Information	12
Tube Dimensions and Labeling Information	12

General Product Information

Product Test Conditions

SnapLED Xtreme LEDs are tested and binned with 20ms monopulse (MP) at 300mA drive current, junction temperature, T_j , of 25°C.

Part Number Nomenclature

Part numbers for SnapLED Xtreme follow the convention below:

A 1 S X – **B C C C D E 3 F G H J 0 0**

Where:

- B** – designates color (O=Red Orange, S=Super Red)
- C C C** – designates minimum dominant wavelength (612=612nm, 632=632nm)
- D** – designates the lens type (B=Batwing)
- E** – designates the binning condition (1=single binning 300mA)
- F** – designates minimum flux bin (See Product Bins and Labeling section)
- G** – designates the flux bin range (3=3 subsequent flux bins including the minimum bin)
- H J** – designates forward voltage range in which H is the minimum Vf bin and J is the maximum Vf bin (See Product Bins and Labeling section)

Therefore, the following part number is used for a SnapLED Xtreme Red Orange, 612nm minimum dominant wavelength, luminous flux range of 43 lumens to 74 lumens and forward voltage range of 2.07 volts to 2.79 volts:

A 1 S X – **O 6 1 2 B 1 3 W 3 A F 0 0**

Environmental Compliance

Lumileds LLC is committed to providing environmentally friendly products to the solid-state lighting market. SnapLED Xtreme is compliant to the European Union directives on the restriction of hazardous substances in electronic equipment, namely the RoHS Directive 2011/65/EU and REACH Regulation (EC) 1907/2006. Lumileds LLC will not intentionally add the following restricted materials to its products: lead, mercury, cadmium, hexavalent chromium, polybrominated biphenyls (PBB) or polybrominated diphenyl ethers (PBDE).

Performance Characteristics

Product Selection Guide

Table 1. Product selection for SnapLED Xtreme at 20ms MP, 300mA, $T_j=25^\circ\text{C}$.

COLOR	TYPICAL DOMINANT WAVELENGTH ^[1,2] (nm)	PART NUMBER
Super Red	635	A1SX - S632B
Red Orange	615	A1SX - O612B

Notes for Table 1:

1. Dominant wavelength is derived from the CIE 1931 Chromaticity diagram and represents perceived color.
2. Lumileds maintains a tolerance of $\pm 1\text{nm}$ for dominant wavelength measurements.

Optical Characteristics

Table 2. Typical optical characteristics for SnapLED Xtreme at 20ms MP, 300mA, $T_j=25^\circ\text{C}$.

PART NUMBER	PEAK HORIZONTAL ANGLE ^[1] 2θ	PEAK VERTICAL ANGLE ^[1] 2θ
A1SX - O612B	130°	60°
A1SX - S632B	130°	60°

Notes for Table 2:

1. The typical off axis peak angle.

Electrical Characteristics

Table 3. Typical electrical characteristics for SnapLED Xtreme at 20ms MP, 300mA, $T_j=25^\circ\text{C}$.

PARAMETER	PERFORMANCE
Forward Voltage, V_f	2.7V
Electrical Thermal Resistance, $R_{th-j-c\text{electr}}$ ^[1] (Maximum)	15°C/W
Real Thermal Resistance, $R_{th-j-c\text{real}}$ ^[2] (Maximum)	20°C/W
Temperature Coefficient of V_f , $I_f = 300\text{mA}$, $10^\circ\text{C} \leq T_c \leq 110^\circ\text{C}$	-3.1mV/°C

Notes for Table 3:

1. $R_{th-j-c\text{electr}}$: Electrical thermal resistance (junction to case).
2. $R_{th-j-c\text{real}}$: Real thermal resistance (junction to case) with wall plug efficiency included. Reference JESD51-51, JESD51-14, 4.1.3.

Absolute Ratings

Table 4. Absolute ratings for SnapLED Xtreme.

PARAMETER	PERFORMANCE
Minimum DC Forward Current	10mA
Maximum DC Forward Current	350mA
Maximum Junction Temperature ^[1]	155°C
Operating Case Temperature at Test Current ^[1]	-40°C to 110°C
Operating Case Temperature at Maximum Current ^[1]	-40°C to 110°C
Storage Temperature	-55°C to 110°C
Soldering Temperature	Not applicable for clinching
Allowable Reflow Cycles	Not applicable for clinching
Minimum ESD performance ^[2]	8kV HBM (Class 3B), 1kV CDM (Class III)
Reverse Voltage (V _r)	-10V

Notes for Table 4:

1. Proper current derating must be observed to maintain junction temperature below the maximum, so that the LED is maintained below the maximum rated operating case temperature. SnapLED LEDs driven at or above the maximum rated operating case temperature may have shorter lifetime.
2. Measured using human body model (per ANSI/ESDA/JEDEC JS-001-2010) and charged device model (per JESD22-C101F).

Characteristic Curves

Spectral Power Distribution Characteristics

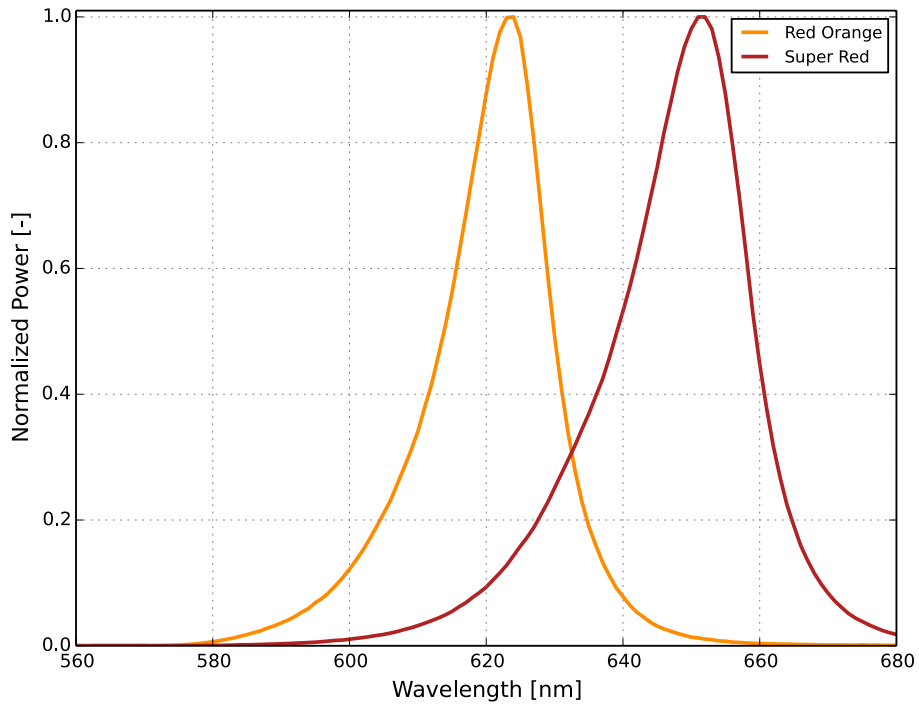

Figure 1: Typical normalized power vs. wavelength for SnapLED Xtreme at 300mA, 20ms MP, $T_j = 25^\circ\text{C}$.

Light Output Characteristics

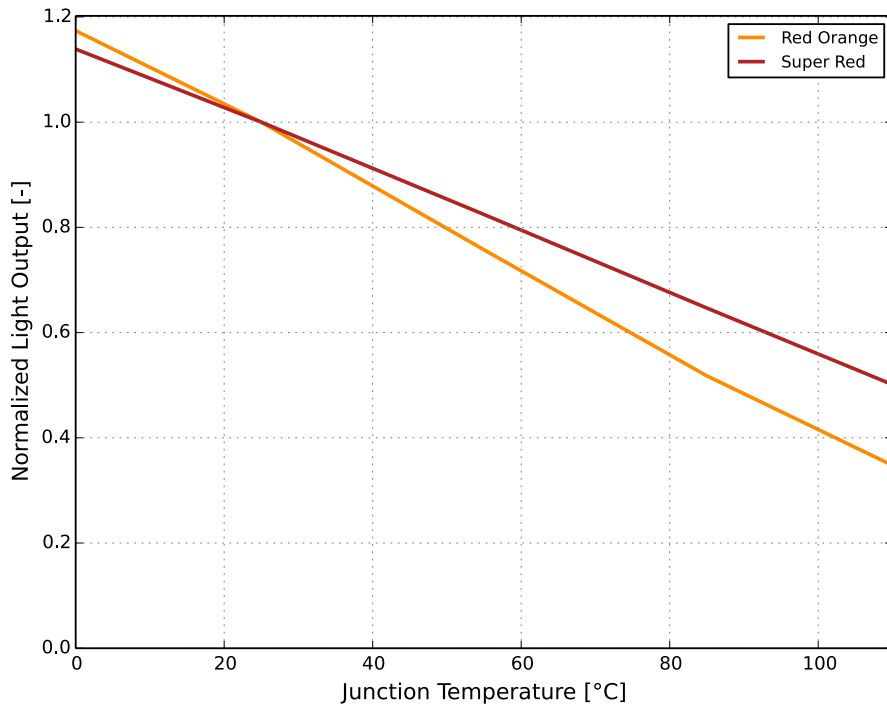

Figure 2: Typical normalized light output vs. junction temperature for SnapLED Xtreme at 300mA, 20ms MP.

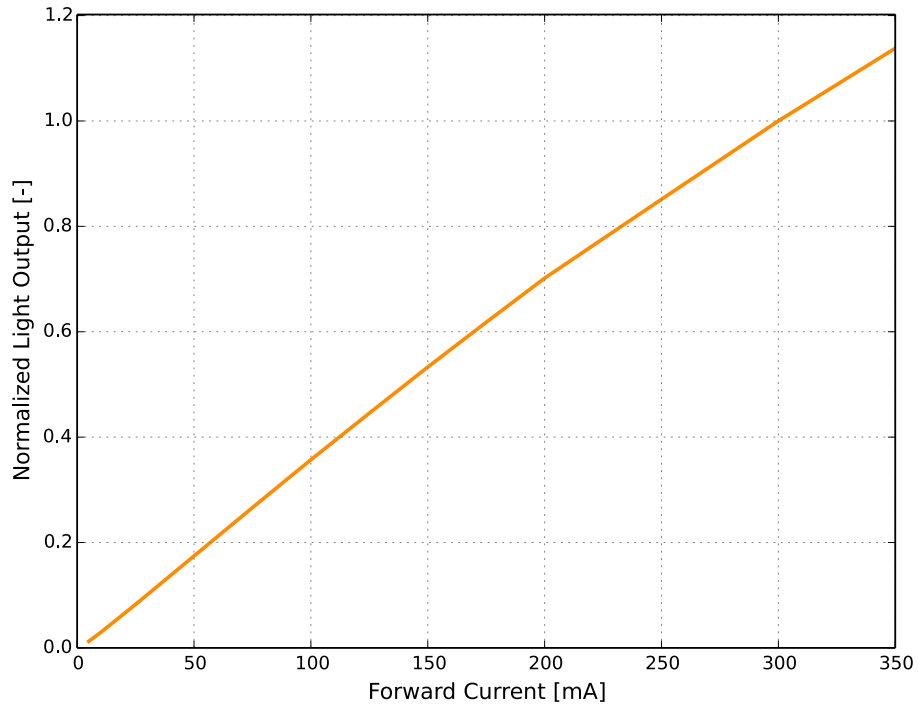

Figure 3: Typical normalized light output vs. forward current for SnapLED Xtreme at $T_j = 25^\circ\text{C}$.

Forward Current Characteristics

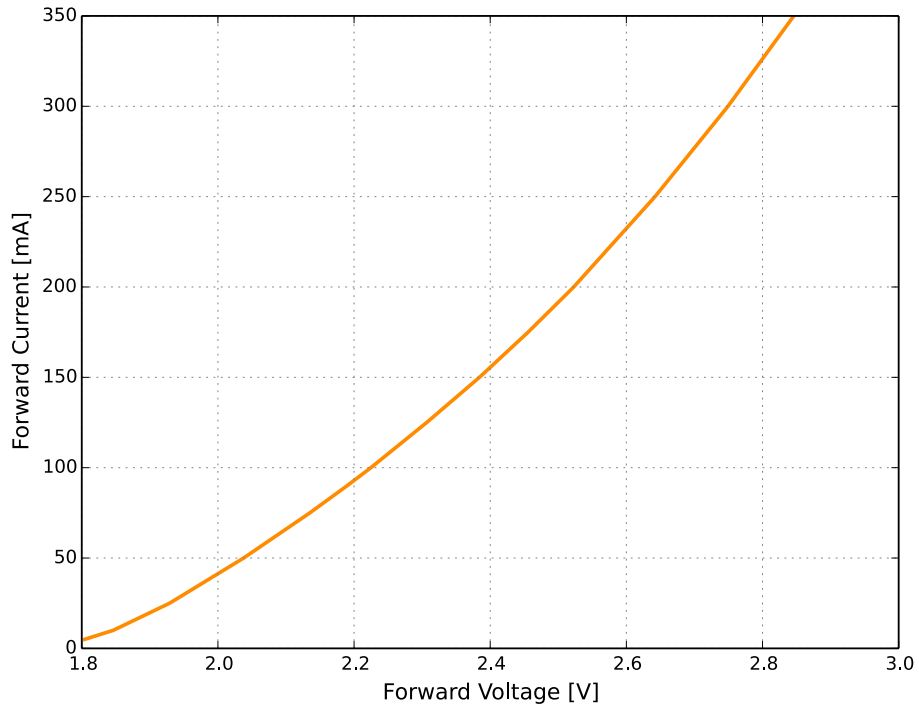

Figure 4a: Typical forward current vs. forward voltage for SnapLED Xtreme at $T_j = 25^\circ\text{C}$.

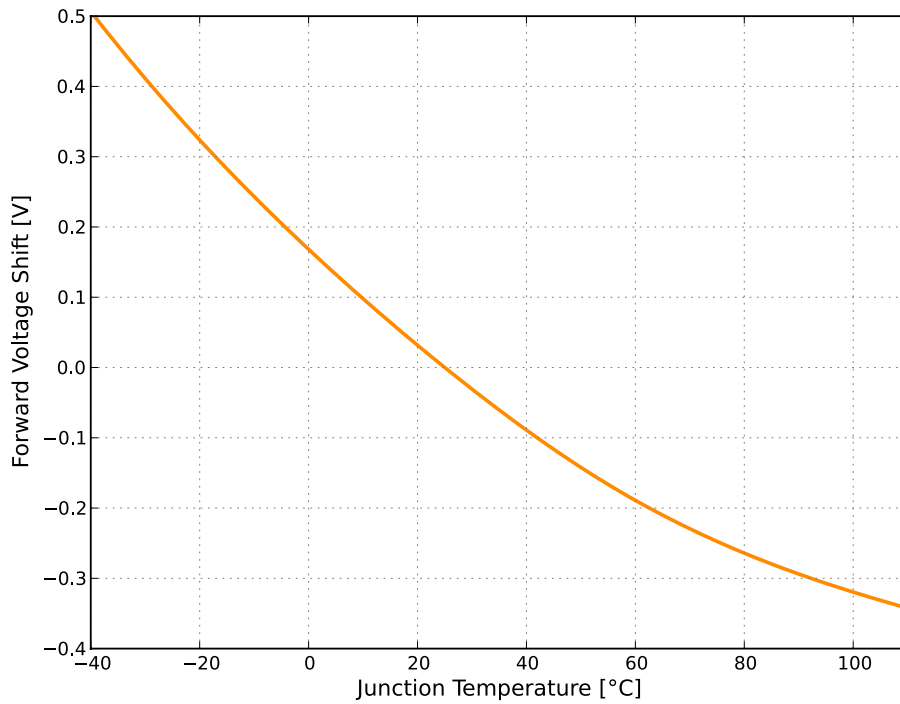

Figure 4b: Typical forward voltage vs. junction temperature for SnapLED Xtreme at 300mA, 20ms MP.

Radiation Pattern Characteristics

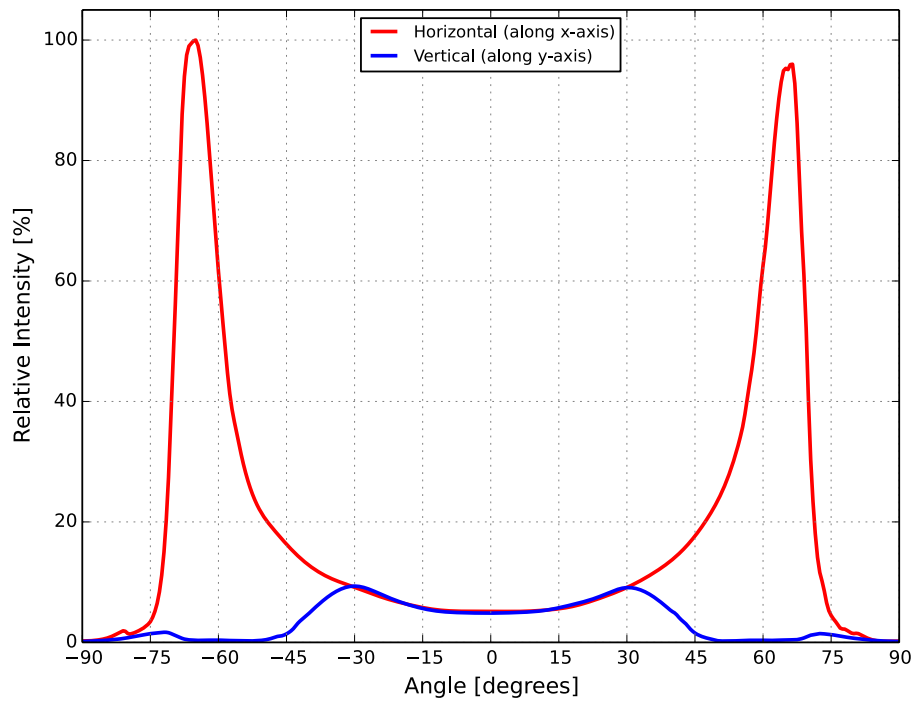

Figure 5: Typical radiation pattern for SnapLED Xtreme at 300mA, 20ms MP.

Operating Limits Characteristics

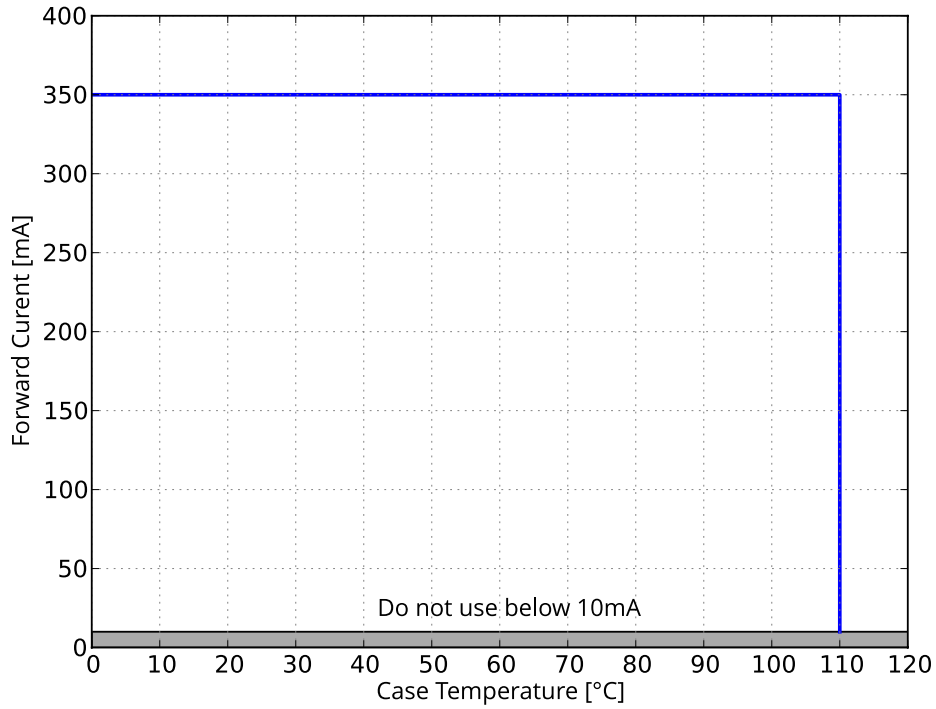

Figure 6: Maximum forward current vs. case temperature for SnapLED Xtreme.

Thermal Resistance

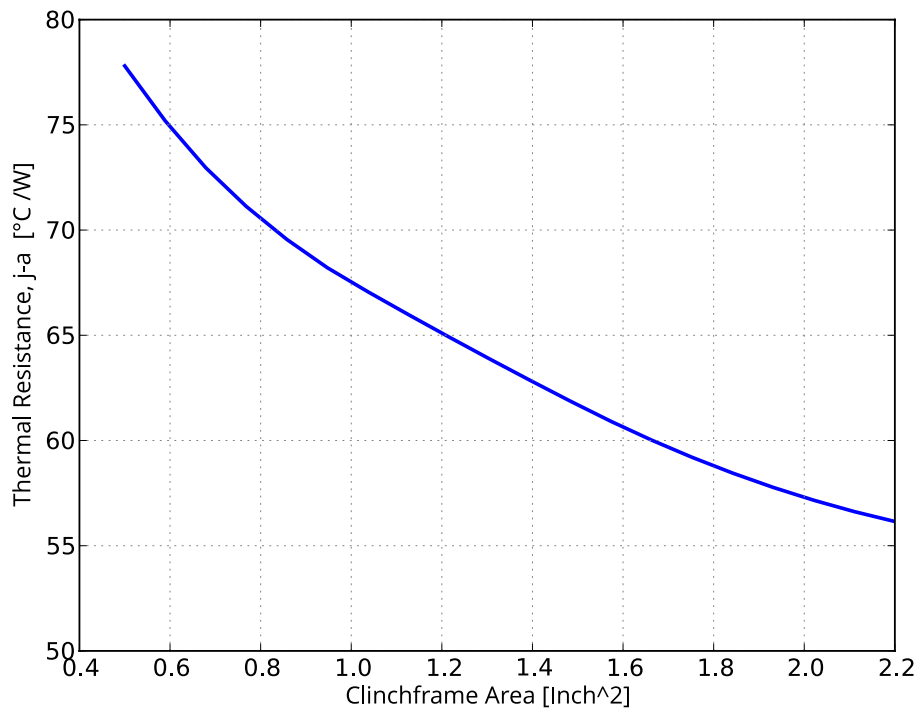

Figure 7: Approximate total thermal resistance vs. clinch frame area per anode.

Product Bin and Labeling Definitions

Designing with SnapLED Xtreme

Flux bins supportable for car programs depend on product color and program start- and end-of-production date. Flux roadmaps by year and product color are maintained and available from the sales representative. Please contact local sales representative to request the flux bin range with best supportability for program timing.

Decoding Product Bin Labeling

In the manufacturing of semiconductor products, there are variations in performance around the average values given in the technical datasheets. For this reason, Lumileds bins the LED components for luminous flux or radiometric power, forward voltage, color point, peak wavelength, or dominant wavelength.

SnapLED Xtreme single binned LEDs are labeled using a 3-digit alphanumeric CAT code following the format below:

A B C

Where:

- A** – designates luminous flux bin (example: W=43 to 52 lumens)
- B** – designates color code (example: 3=612nm to 618nm)
- C** – designates forward voltage bin (example: B=2.19V to 2.31V)

Therefore, a SnapLED Xtreme with a lumen range of 43 to 52 lumens, dominant wavelength range of 612 to 618nm and a forward voltage range of 2.19 to 2.31V has the following CAT code:

W 3 B

Luminous Flux Bins

Table 5 lists the standard photometric luminous flux bins for SnapLED Xtreme emitters. Product availability in a particular bin varies by color and platform start of production date. Contact local sales representative for best supportability of programs.

Table 5. High current luminous flux bin definitions for SnapLED Xtreme at 20ms MP, 300mA, T_j=25°C.

BIN	LUMINOUS FLUX (lm)	
	MINIMUM	MAXIMUM
W	43.0	52.0
X	52.0	62.0
Y	62.0	74.0

Notes for Table 5:

1. Lumileds maintains a tolerance of ±10% on luminous flux measurements.

Color Codes

Table 6. Color code definitions for SnapLED Xtreme at 20ms MP, 300mA, $T_j=25^\circ\text{C}$.

CODE	DOMINANT WAVELENGTH (nm)	
	MINIMUM	MAXIMUM
3	612	618
5	632	638

Notes for Table 6:

1. Lumileds maintains a tolerance of $\pm 1\text{nm}$ on dominant wavelength measurements.

Forward Voltage Bins

Table 7. High current forward voltage bin definitions for SnapLED Xtreme at 20ms MP, 300mA, $T_j=25^\circ\text{C}$.

BIN	FORWARD VOLTAGE (V)	
	MINIMUM	MAXIMUM
A	2.07	2.19
B	2.19	2.31
C	2.31	2.43
D	2.43	2.55
E	2.55	2.67
F	2.67	2.79

Notes for Table 7:

1. Lumileds maintains a tolerance of $\pm 0.06\text{V}$ on forward voltage measurements.

Mechanical Dimensions

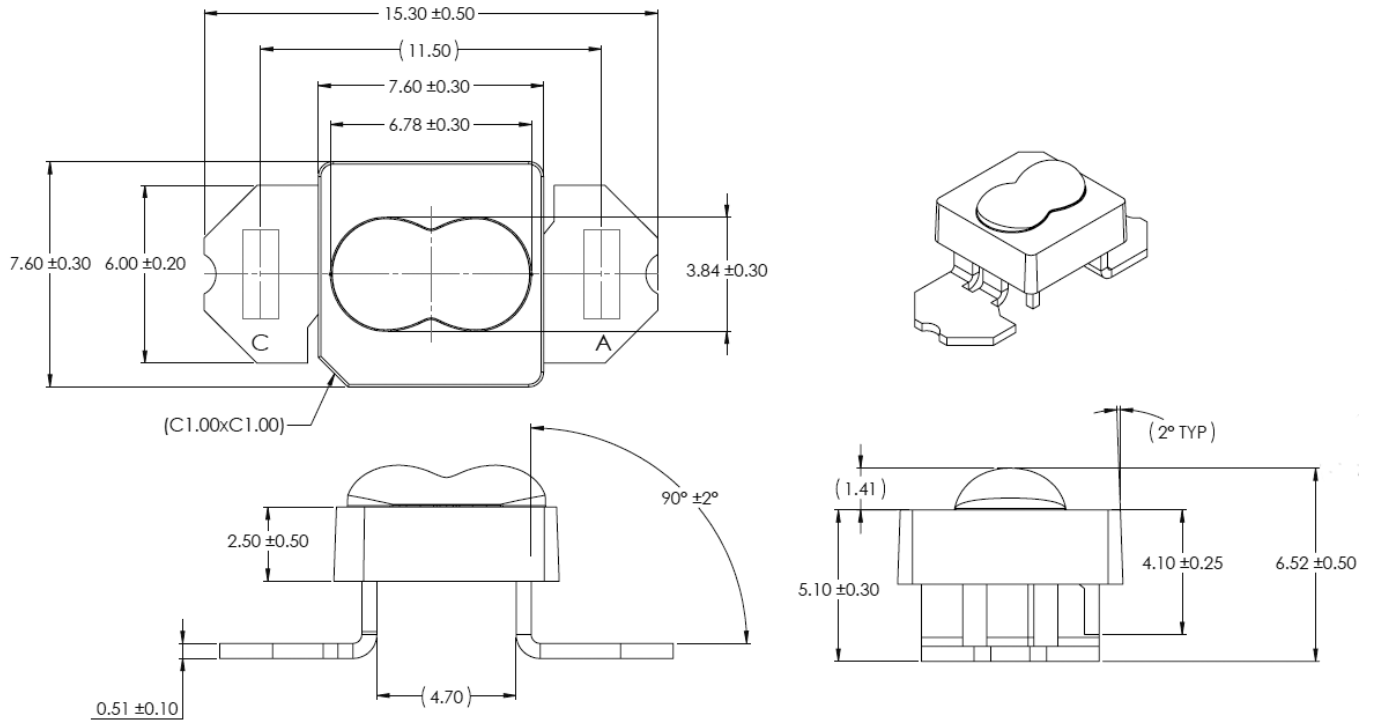

Figure 8: Mechanical dimensions for SnapLED Xtreme.

Notes for Figure 8:

1. Drawings are not to scale.
2. All dimensions are in millimeters.
3. Cathode lead is indicated with a "C" and anode lead is indicated with an "A" (image is for illustration purposes only).
4. Clinch joint locations shown in dashed lines on top view of the emitter (11.5mm spacing).

Packaging Information

SnapLED Xtreme LEDs are packaged in tubes for use with automatic insertion equipment then shrink wrapped into bundles and shipped in boxes measuring (49.2cm x 20.1 cm x 11.8 cm).

Each tube contains a specified number of LEDs. The LEDs in each tube come from a single category code, ensuring they are all well-matched for light output, color, and forward voltage.

Each tube contains a rubber stopper at one end. The tube label has both alphanumeric and bar code information. The bundles have printed information providing part numbers with CAT codes that indicate luminous flux, color and forward voltage bins.

Table 8. Number of LEDs per tube for SnapLED Xtreme.

TOTAL UNITS per TUBE	TOTAL TUBES per BUNDLE	TOTAL UNITS per BUNDLE/BOX
60	10	600

Tube Dimensions and Labeling Information

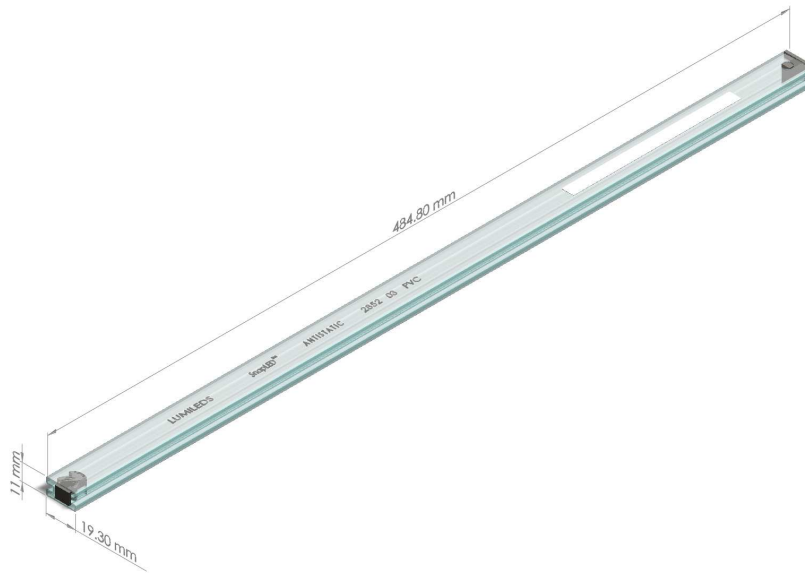

Figure 9a: Tube dimensions for SnapLED Xtreme.

Notes for Figure 9a:

1. Drawings are not to scale.
2. All dimensions are in millimeters.

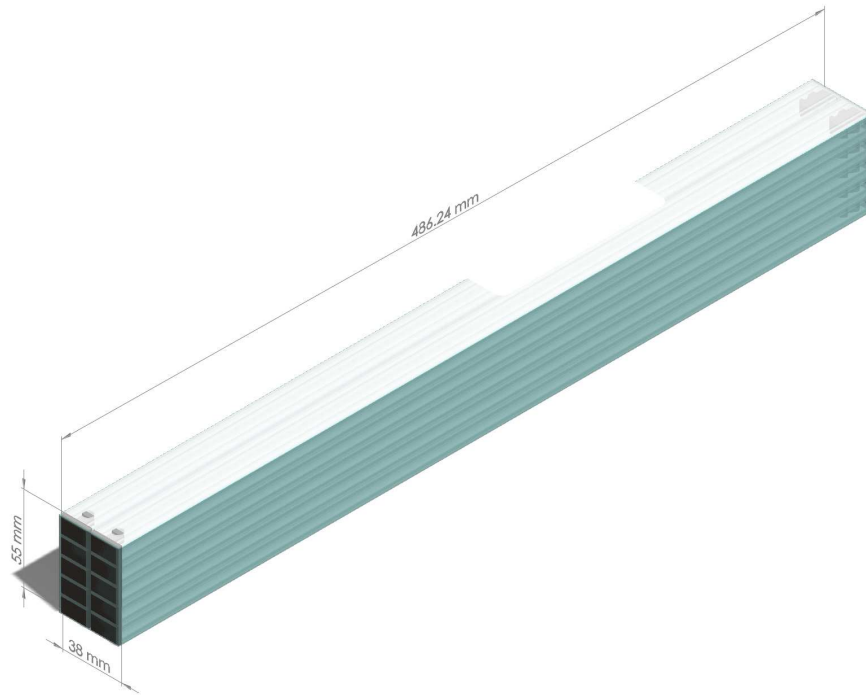

Figure 9b. Bundle dimensions for SnapLED Xtreme.



Figure 9c. Example of SnapLED Xtreme tube label.

- Notes for Figures 9b and 9c:
1. Drawings are not to scale.
 2. All dimensions are in millimeters.



Figure 10. Example of SnapLED Xtreme bundle and box label.

About Lumileds

Lumileds is the global leader in light engine technology. The company develops, manufactures and distributes groundbreaking LEDs and automotive lighting products that shatter the status quo and help customers gain and maintain a competitive edge. With a rich history of industry “firsts,” Lumileds is uniquely positioned to deliver lighting advancements well into the future by maintaining an unwavering focus on quality, innovation and reliability.

To learn more about our portfolio of light engines, visit lumileds.com.



©2015 Lumileds Holding B.V. All rights reserved.
LUXEON is a registered trademark of the Lumileds Holding B.V.
in the United States and other countries.

lumileds.com

Neither Lumileds Holding B.V. nor its affiliates shall be liable for any kind of loss of data or any other damages, direct, indirect or consequential, resulting from the use of the provided information and data. Although Lumileds Holding B.V. and/or its affiliates have attempted to provide the most accurate information and data, the materials and services information and data are provided “as is,” and neither Lumileds Holding B.V. nor its affiliates warrants or guarantees the contents and correctness of the provided information and data. Lumileds Holding B.V. and its affiliates reserve the right to make changes without notice. You as user agree to this disclaimer and user agreement with the download or use of the provided materials, information and data.