

LUXEON F Plus Cool White

Industry-leading solutions for low and high beam lamps

LUXEON F Plus Cool White LEDs are the only automotive LEDs that deliver design flexibility and advanced functionality. These products, with their miniaturized form factor, are designed to support daytime running lamps, front fog and low and high beam applications. The Lumileds automotive binning structure meets both SAE and ECE color specifications and is hot binned at 85°C, consistent with actual automotive operational environments. LUXEON F Plus Cool White provides an industry-leading solution for your front and rear applications. All LUXEON F LEDs are AEC-Q102 qualified.

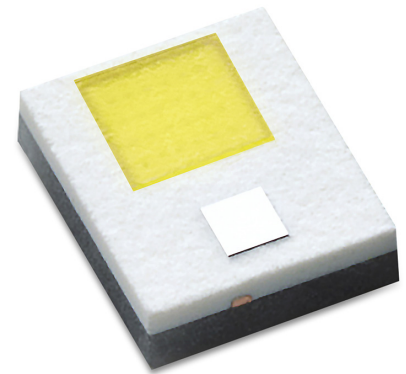
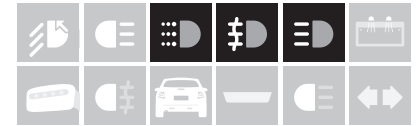

FEATURES AND BENEFITS

Higher drive current capability for increased flux performance

Low thermal resistance for better hot lumen performance

Standard packaging for low cost and ease of manufacturability

Hot binned at 85°C MP to match closer to operating conditions

IEC/PAS62707-1 White LED

PRIMARY APPLICATIONS

Daytime Running Lights

Front Fog

Headlight

- Low Beam

- High Beam

- Cornering Light

Table of Contents

General Product Information	2
Product Test Conditions	2
Part Number Nomenclature	2
Environmental Compliance	2
Performance Characteristics	3
Product Selection Guide	3
Optical Characteristics	3
Electrical Characteristics	3
Absolute Ratings	4
JEDEC Moisture Sensitivity	4
Characteristic Curves	5
Spectral Power Distribution Characteristics	5
Light Output Characteristics	5
Forward Current and Voltage Characteristics	6
Color Shift Characteristics	7
Radiation Pattern Characteristics	9
Operating Limits Characteristics	9
Permissible Pulse Handling Characteristics	10
Product Bin and Labeling Definitions	11
Designing with LUXEON F Plus Cool White	11
Decoding Product Bin Labeling	11
Luminous Flux Bins	11
Color Codes	12
Color Bin Definitions	13
Forward Voltage Bins	14
Mechanical Dimensions	14
Packaging Information	15
Pocket Tape Dimensions	15
Reel Dimensions	15

General Product Information

Product Test Conditions

LUXEON F Plus Cool White LEDs are tested and binned using a <20ms monopulse (MP) at 1000mA drive current, case temperature, T_c , of 85°C.

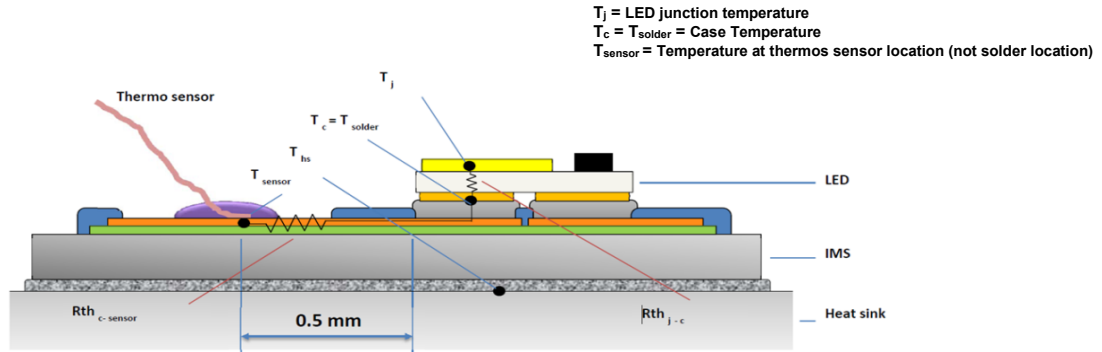

Figure 1. Example of case temperature location on sample board for LUXEON F Plus Cool White.

Part Number Nomenclature

Part numbers for LUXEON F Plus Cool White follow the convention below:

L F T H – A B C – E F G H

Where:

- L – designates LUXEON
- F – designates LUXEON F product family
- T H – designates hot binning
- A – designates color variant (C=White)
- B – designates die size (1=1mm²)
- C – designates binning current (C=1000mA)
- E – designates future product offerings
- F G H – designates minimum luminous flux

Therefore, the following part number is used for a LUXEON F Plus Cool White with a minimum luminous flux of 268 lumens:

L F T H – C 1 C – 0 2 6 8

Environmental Compliance

Lumileds LLC is committed to providing environmentally friendly products to the solid-state lighting market. LUXEON F Plus Cool White is compliant to the European Union directives on the restriction of hazardous substances in electronic equipment, namely the RoHS Directive 2011/65/EU and REACH Regulation (EC) 1907/2006. Lumileds LLC will not intentionally add the following restricted materials to its products: lead, mercury, cadmium, hexavalent chromium, polybrominated biphenyls (PBB) or polybrominated diphenyl ethers (PBDE).

Performance Characteristics

Product Selection Guide

Table 1. Product selection for LUXEON F Plus Cool White at <20ms MP test current, $T_c=85^\circ\text{C}$.

MINIMUM LUMINOUS FLUX ^[1] (lm)	TEST CURRENT (mA)	PART NUMBER
268	1000	LFTH-C1C-0268
288	1000	LFTH-C1C-0288
309	1000	LFTH-C1C-0309

Notes for Table 1:

1. Dominant wavelength is derived from the CIE 1931 Chromaticity diagram and represents perceived color.
2. Lumileds maintains a tolerance of $\pm 6.5\%$ on luminous flux measurements.

Optical Characteristics

Table 2. Typical optical characteristics for LUXEON F Plus Cool White at <20ms MP test current, $T_c=85^\circ\text{C}$.

PART NUMBER	CORRELATED COLOR TEMPERATURE		TOTAL INCLUDED ANGLE ^[1] $\theta_{0.90V}$	VIEWING ANGLE ^[2] $2\theta_{1/2}$
	MINIMUM	MAXIMUM		
LFTH-C1C-0XXX	5500K	6250K	142°	120°

Notes for Table 2:

1. Total angle at which 90% of total luminous flux is captured.
2. Viewing angle is the off axis angle from the LED centerline where the luminous intensity is $\frac{1}{2}$ of the peak value.

Electrical Characteristics

Table 3. Typical electrical characteristics for LUXEON F Plus Cool White at MP test current, $T_c=85^\circ\text{C}$.

PART NUMBER	FORWARD VOLTAGE (V) ^[1]		DYNAMIC RESISTANCE ^[2] (Ω) R_D	TEMPERATURE COEFFICIENT OF FORWARD VOLTAGE ^[3] ($\text{mV}/^\circ\text{C}$) $\Delta V_f / \Delta T_j$	TYPICAL THERMAL RESISTANCE JUNCTION TO CASE ($^\circ\text{C}/\text{W}$)			
	MINIMUM	MAXIMUM			$R\theta_{j-c} \text{ el}^{[4]}$		$R\theta_{j-c} \text{ real}^{[5]}$	
					TYPICAL	MAXIMUM	TYPICAL	MAXIMUM
LFTH-C1C-0XXX	2.55	3.27	0.3	-2.1	2.30	2.60	3.27	3.69

Notes for Table 3:

1. Lumileds maintains a tolerance of ± 0.06 V on forward voltage measurements.
2. Dynamic resistance is the inverse of the slope in linear forward voltage model for LEDs. See forward voltage vs. forward current Figure 4.
3. Measured between $T_c=80^\circ\text{C}$ and $T_c=90^\circ\text{C}$ at binning current.
4. $R\theta_{j-c} \text{ el}$: Electrical thermal resistance (junction to case).
5. $R\theta_{j-c} \text{ real}$: Real thermal resistance (junction to case) with wall plug efficiency included. Reference JESD51-51, JESD51-14, 4.1.3.

Absolute Ratings

Table 4. Absolute ratings for LUXEON F Plus Cool White.

PARAMETER	PERFORMANCE
Minimum DC Forward Current	50mA
Maximum DC Forward Current	1500mA
Maximum Junction Temperature ^[1]	150°C
Maximum Junction Temperature for <200 Hours (1500mA)	175°C
Operating Case Temperature at Test Current ^[1]	-40°C to 130°C
Operating Case Temperature at Maximum Current ^[1]	-40°C to 130°C
LED Storage Temperature	-40°C to 130°C
Maximum Soldering Temperature	260°C
Allowable Reflow Cycles	3
ESD Sensitivity ^[2]	±8 kV HBM, ±400 V MM, ±2kV CDM
Reverse Voltage (V _r)	LUXEON LEDs are not designed to be driven in reverse bias
Autoclave Conditions	121°C at 2 ATM 100% Relative Humidity for 96 Hours Maximum

Notes for Table 4:

- Proper current derating must be observed to maintain junction temperature below the maximum, so that the LED is maintained below the maximum rated operating case temperature. LUXEON F Plus Cool White LEDs driven at or above the maximum rated operating case temperature may have shorter lifetime.
- Measured using human body model (per JESD22 A114), machine model (per JESD22 A115) and charged device model (per JESD22-C101F).

JEDEC Moisture Sensitivity

Table 5. Moisture sensitivity levels for LUXEON F Plus Cool White.

LEVEL	FLOOR LIFE		SOAK REQUIREMENTS STANDARD	
	TIME	CONDITIONS	TIME	CONDITIONS
1	Unlimited	≤30°C / 85% RH	168 Hours +5 / -0	85°C / 85% RH

Characteristic Curves

Spectral Power Distribution Characteristics

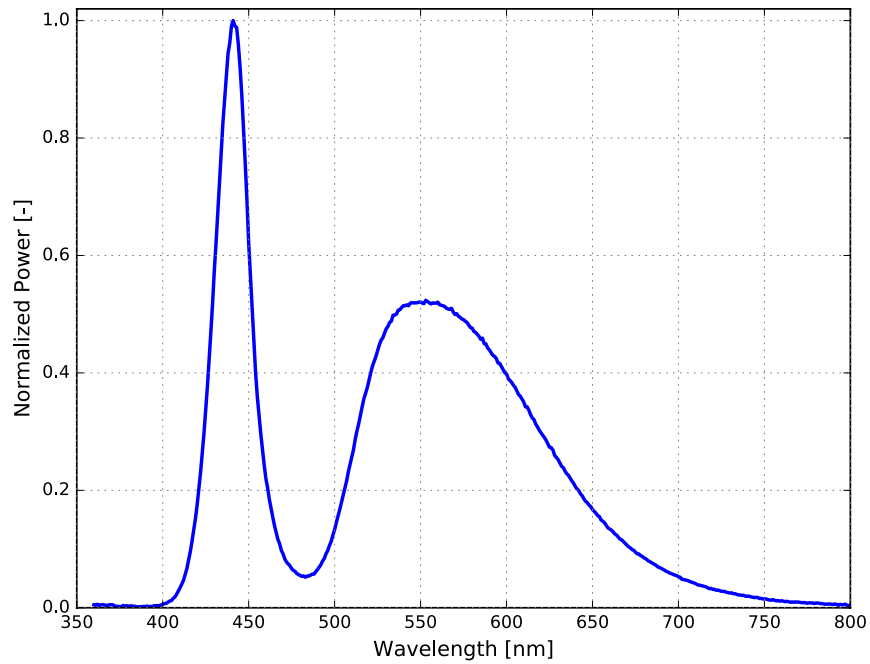

Figure 2. Typical normalized power vs. wavelength for LUXEON F Plus Cool White at <20ms MP 1000mA, $T_c=85^\circ\text{C}$.

Light Output Characteristics

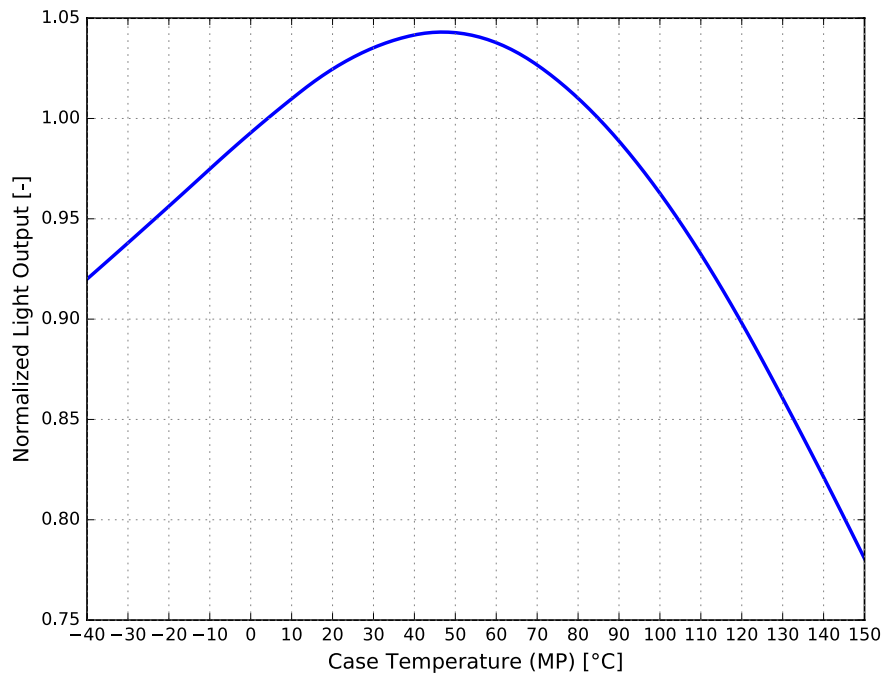

Figure 3. Typical normalized light output vs. junction temperature for LUXEON F Plus Cool White at <20ms MP, 1000mA.

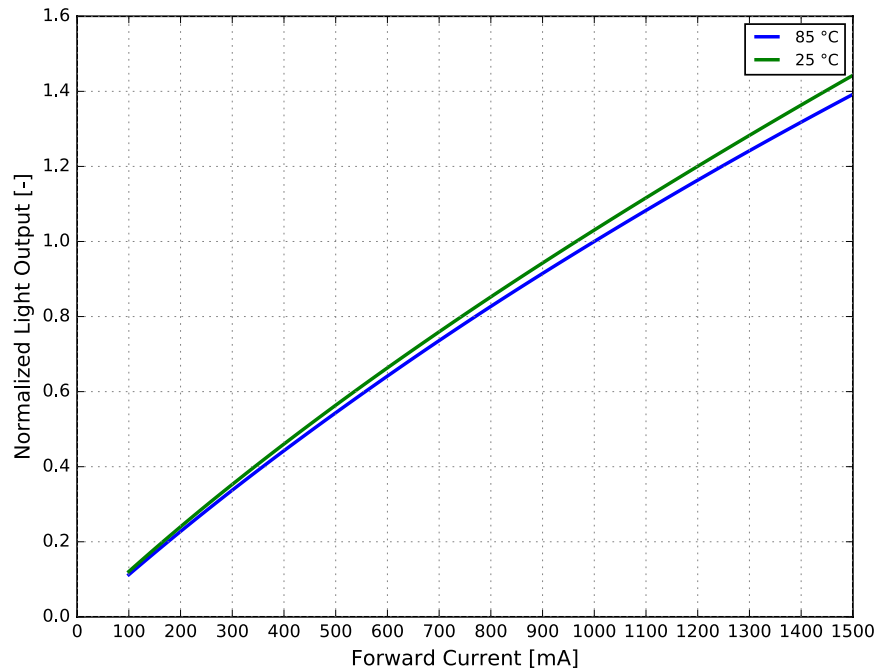

Figure 4. Typical normalized light output vs. forward current for LUXEON F Plus Cool White at $T_c=85^\circ\text{C}$.

Forward Current and Voltage Characteristics

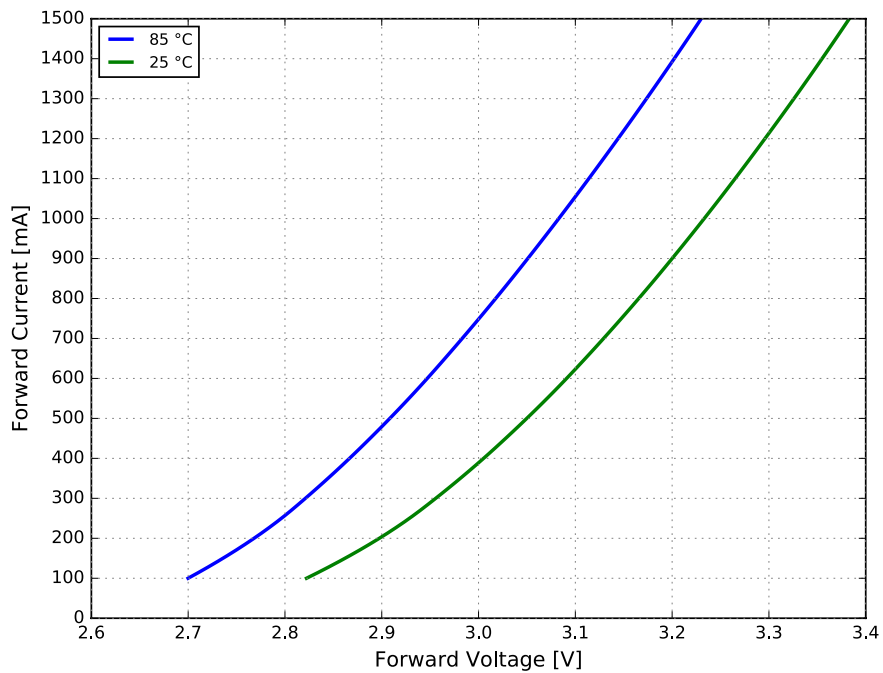

Figure 5. Typical forward current vs. forward voltage for LUXEON F Plus Cool White at $T_c=85^\circ\text{C}$.

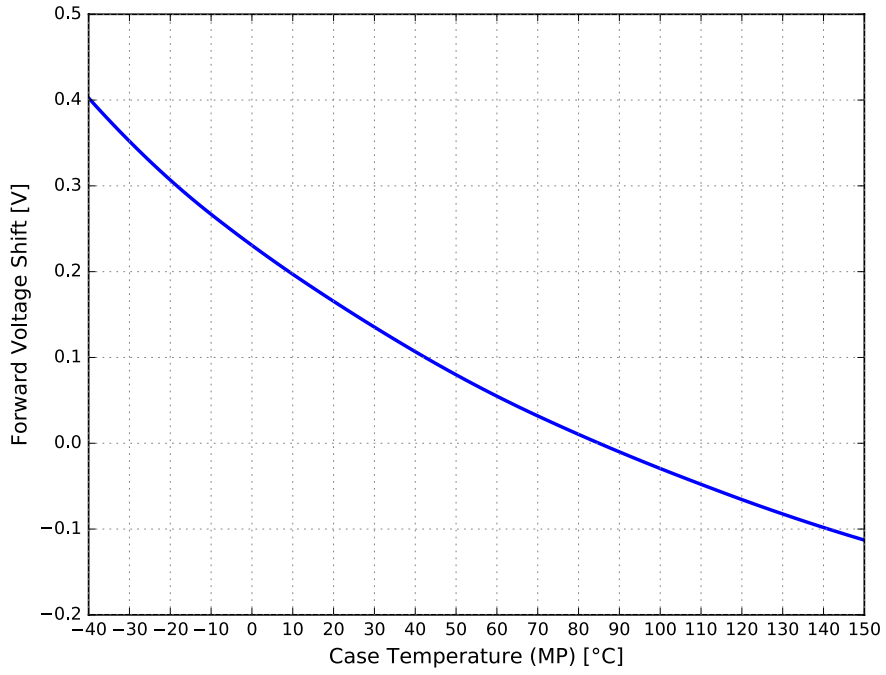

Figure 6. Typical forward voltage shift vs. case temperature for LUXEON F Plus Cool White.

Color Shift Characteristics

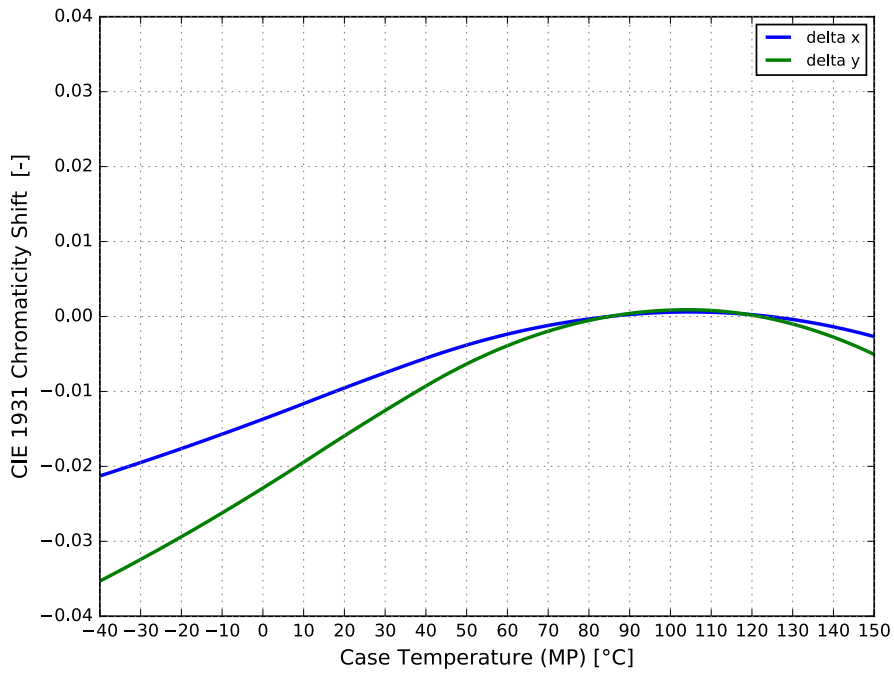

Figure 7. Typical color shift in CIE 1931 x, y coordinates for LUXEON F Plus Cool White at <20ms MP, 1000mA.

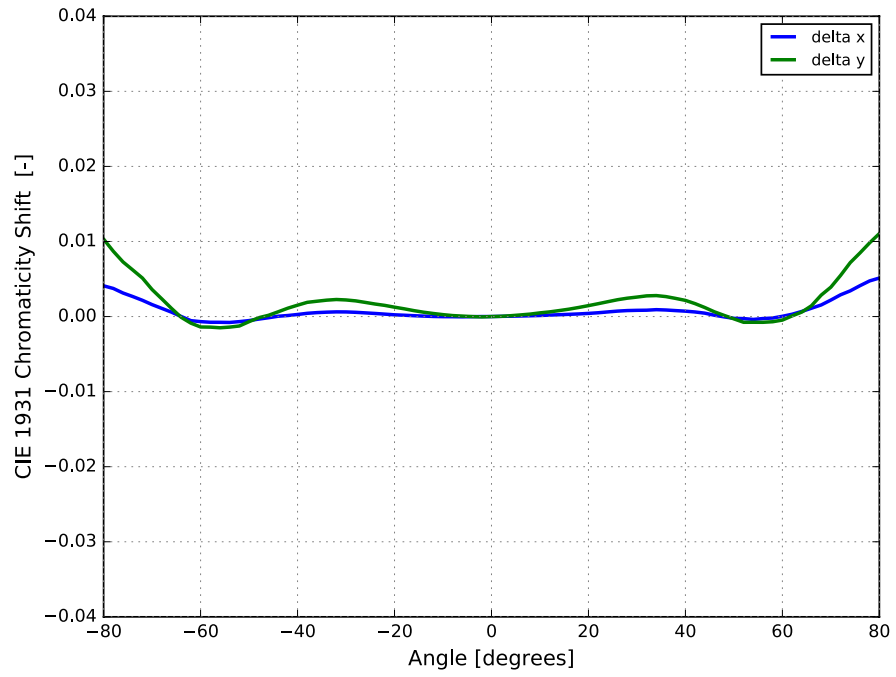

Figure 8. Typical color shift in CIE 1931 x, y coordinates over angle for LUXEON F Plus Cool White at <20ms MP, 1000mA.

Radiation Pattern Characteristics

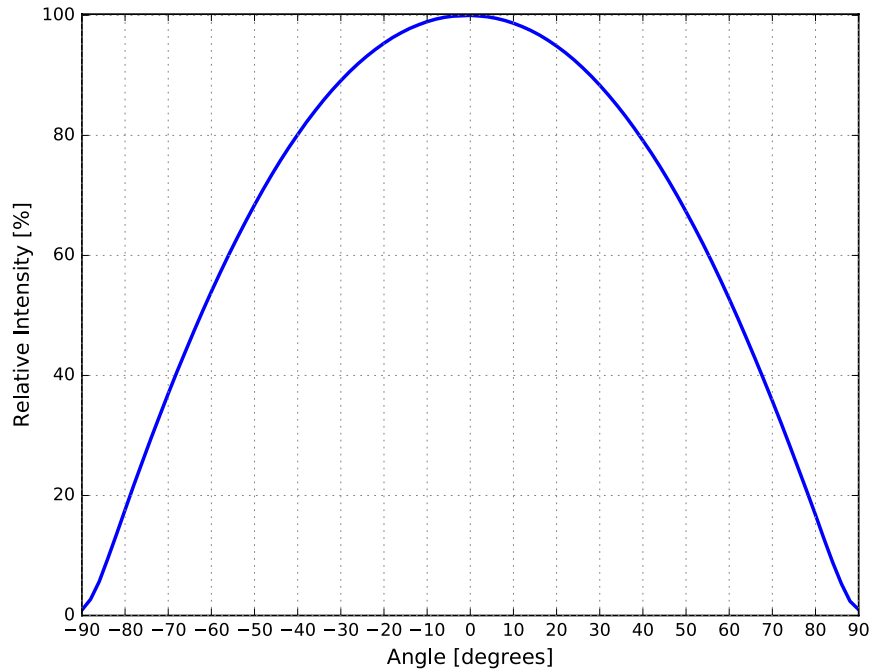

Figure 9. Typical radiation pattern for LUXEON F Plus Cool White at <20ms MP 1000mA, $T_c=85^\circ\text{C}$.

Operating Limits Characteristics

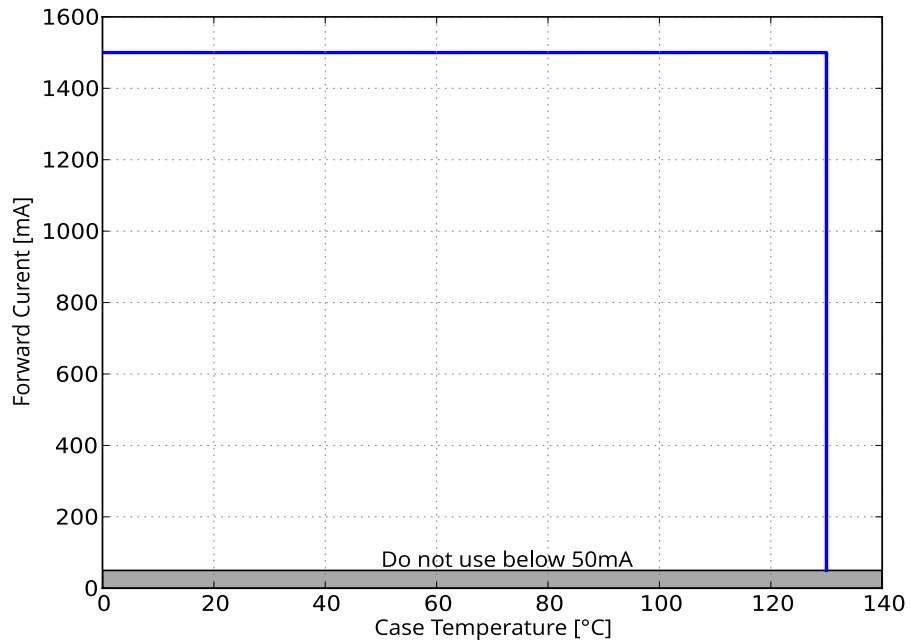

Figure 10. Maximum forward current vs. case temperature for LUXEON F Plus Cool White.

Permissible Pulse Handling Characteristics

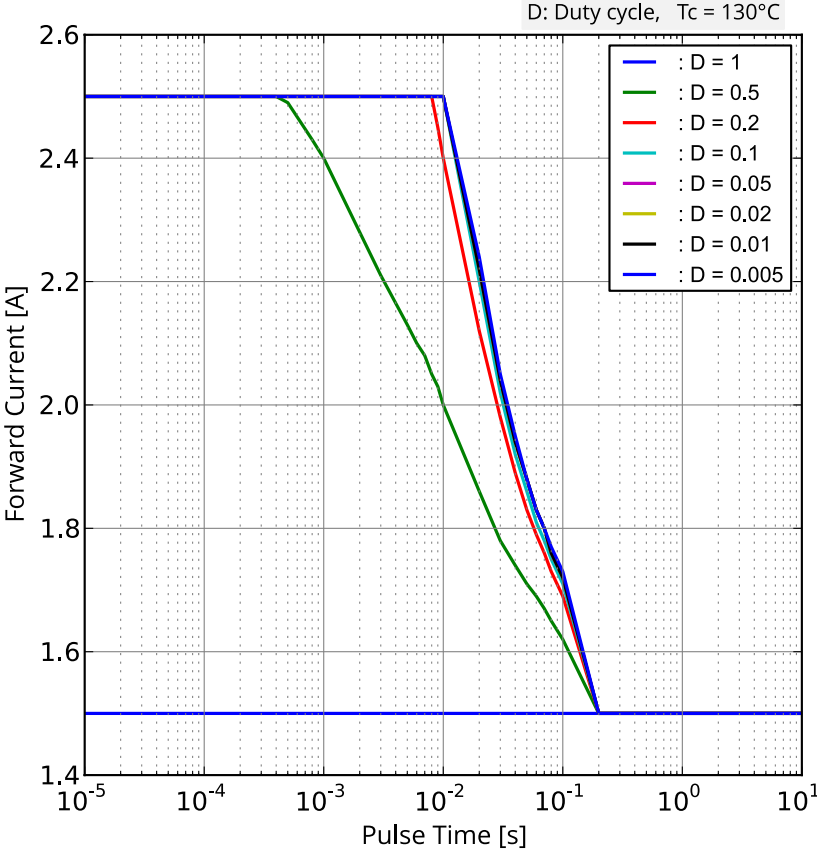

Figure 11. Permissible pulse handling capability for LUXEON F Plus Cool White.

Product Bin and Labeling Definitions

Designing with LUXEON F Plus Cool White

Flux bins supportable for car programs depend on product color and program start- and end-of-production date. Flux roadmaps by year and product color are maintained and available from the sales representative. Please contact local sales representative to request the flux bin range with best supportability for program timing.

Decoding Product Bin Labeling

In the manufacturing of semiconductor products, there are variations in performance around the average values given in the technical datasheets. For this reason, Lumileds bins the LED components for luminous flux or radiometric power, forward voltage, color point, peak wavelength, or dominant wavelength.

LUXEON F Plus Cool White LEDs are labeled using a 4-digit alphanumeric CAT code following the format below:

A B C D

Where:

- A** – designates luminous flux bin (example: W=268 to 288 lumens)
- B C** – designates color code (example: 1A, 1B, 1C, 1D)
- D** – designates forward voltage bin (example: B=2.55V to 2.79V)

Therefore, a LUXEON F Plus Cool White with a lumen range of 268 to 288, color bin of 1D and a forward voltage of 2.55V to 2.79V has the following CAT code:

W 1 D B

Luminous Flux Bins

Table 6 lists the standard photometric luminous flux bins for LUXEON F Plus Cool White emitters. Product availability in a particular bin varies by color and platform start of production date. Contact local sales representative for best supportability of programs.

Table 6. Luminous flux bin definitions for LUXEON F Plus Cool White at <20ms MP test current, $T_c=85^\circ\text{C}$.

BIN	LUMINOUS FLUX (lm)	
	MINIMUM	MAXIMUM
W	268	288
X	288	309
Y	309	330
Z	330	350

Notes for Table 6:

1. Lumileds maintains a tolerance of $\pm 6.5\%$ on luminous flux measurements.

Color Codes

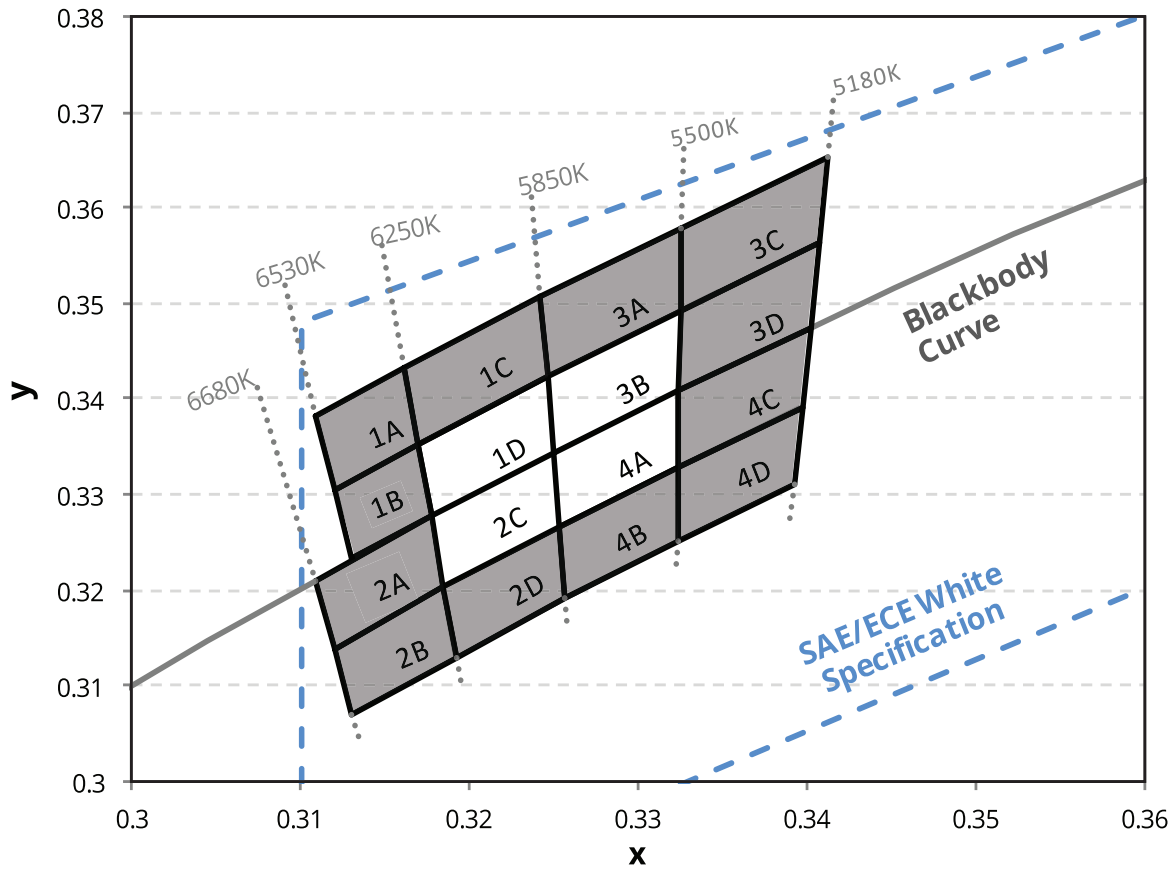

Figure 12. Color bin structure in CIE 1931 color space for LUXEON F Plus Cool White.

Notes for Figure 12:

1. Lumileds supports the following bins for LUXEON F Plus Cool White: 1D, 2C, 3B and 4A.
2. LUXEON F historical large color notations. Color bins must be ordered by fine bin designators, shown below.
 - H1 = 1A, 1B, 1C, 1D
 - H2 = 2A, 2B, 2C, 2D
 - H3 = 3A, 3B, 3C, 3D
 - H4 = 4A, 4B, 4C, 4D
 - HC = 1D, 2C, 3B, 4A

Color Bin Definitions

Table 7. Color bin definitions for LUXEON F Plus Cool White.

BIN	x	y	6-DIGIT IEC CODE	Typical CCT	BIN	x	y	6-DIGIT IEC CODE	Typical CCT
2B	0.3120	0.3139	ebvG33	6460K	1B	0.3120	0.3306	fbwA23	6390K
	0.3185	0.3203				0.3169	0.3353		
	0.3192	0.3131				0.3177	0.3277		
	0.3131	0.3070				0.3131	0.3232		
2D	0.3185	0.3203	ebyG33	6050K	1D	0.3169	0.3353	fbyA33	6050K
	0.3253	0.3266				0.3246	0.3424		
	0.3256	0.3191				0.3249	0.3344		
	0.3192	0.3131				0.3177	0.3277		
4B	0.3253	0.3266	ecbG33	5680K	3B	0.3246	0.3424	fcbA33	5680K
	0.3323	0.3329				0.3325	0.3493		
	0.3323	0.3251				0.3324	0.3410		
	0.3256	0.3191				0.3249	0.3344		
4D	0.3323	0.3329	eceG33	5350K	3D	0.3325	0.3493	fceA33	5350K
	0.3396	0.3392				0.3406	0.3562		
	0.3392	0.3310				0.3401	0.3476		
	0.3323	0.3251				0.3324	0.3410		
2A	0.3109	0.3211	ebvD33	6460K	1A	0.3109	0.3382	fbwD23	6390K
	0.3177	0.3277				0.3161	0.3432		
	0.3185	0.3203				0.3169	0.3353		
	0.3120	0.3139				0.3120	0.3306		
2C	0.3177	0.3277	ebyD33	6050K	1C	0.3161	0.3432	fbyD33	6050K
	0.3249	0.3344				0.3242	0.3506		
	0.3253	0.3266				0.3246	0.3424		
	0.3185	0.3203				0.3169	0.3353		
4A	0.3249	0.3344	ecbD33	5680K	3A	0.3242	0.3506	fcbD33	5680K
	0.3324	0.3410				0.3325	0.3579		
	0.3323	0.3329				0.3325	0.3493		
	0.3253	0.3266				0.3246	0.3424		
4C	0.3324	0.3410	eceD33	5350K	3C	0.3325	0.3579	fceD33	5350K
	0.3401	0.3476				0.3412	0.3652		
	0.3396	0.3392				0.3406	0.3562		
	0.3323	0.3329				0.3325	0.3493		

Notes for Table 7:

1. Lumileds maintains a tolerance of ± 0.005 on x and y coordinates in the CIE 1931 color space.
2. CIE 1931 x and y coordinate frame.

Forward Voltage Bins

Table 8. Forward voltage bin definitions for LUXEON F Plus Cool White.

BIN	FORWARD VOLTAGE ^[1] (V _f)	
	MINIMUM	MAXIMUM
B	2.55	2.79
C	2.79	3.03
D	3.03	3.27

Notes for Table 8:

1. Lumileds maintains a tolerance of $\pm 0.06V$ on forward voltage measurements.
2. Although several bins are outlined, product availability in a particular bin varies by production run and by product performance.

Mechanical Dimensions

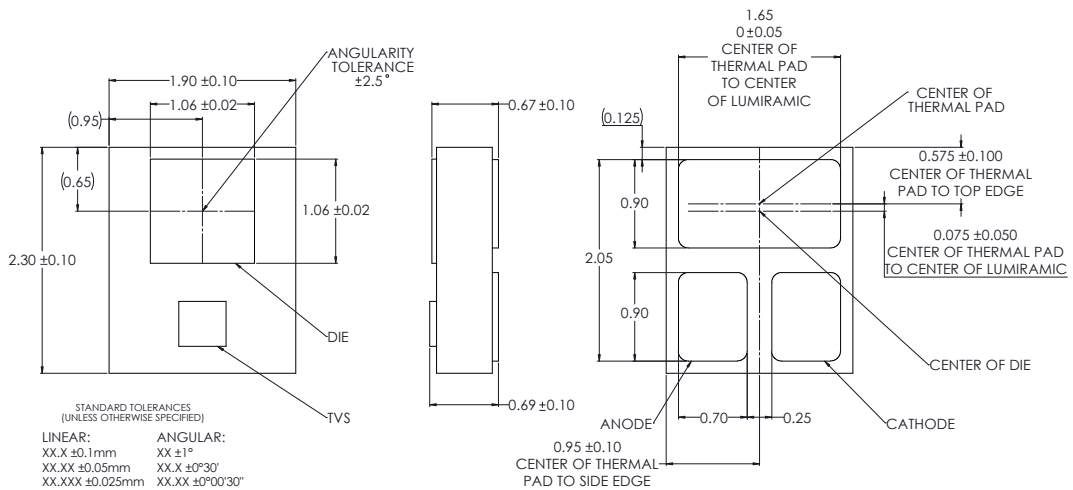

Figure 13. Mechanical dimensions for LUXEON F Plus Cool White.

Notes for Figure 13:

1. Drawings are not to scale.
2. All dimensions are in millimeters.

Packaging Information

Pocket Tape Dimensions

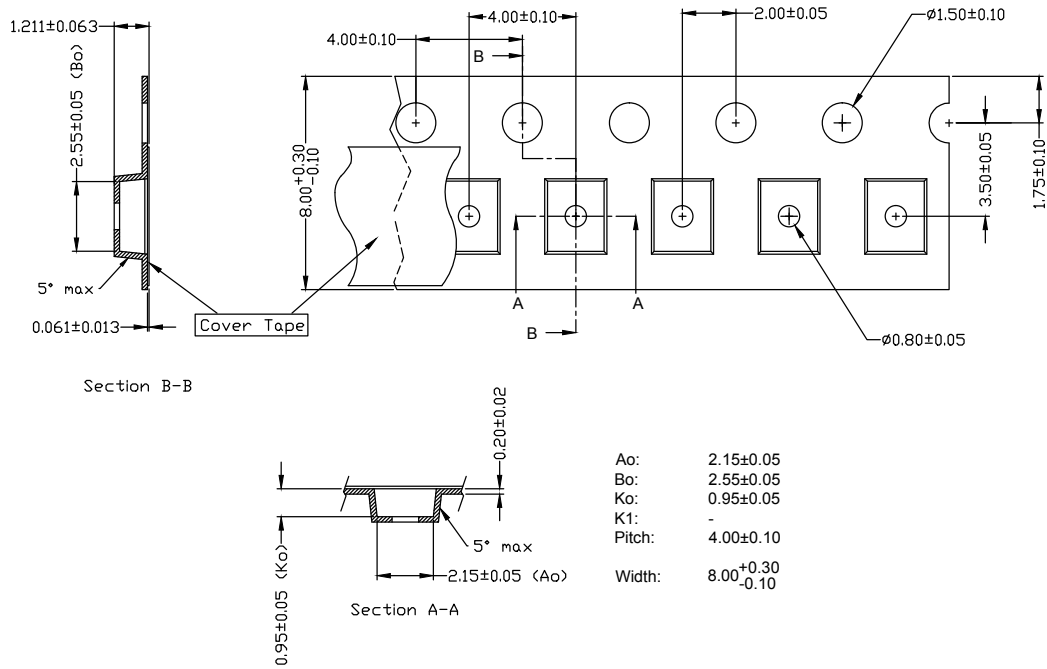

Figure 14. Pocket tape dimensions for LUXEON F Plus Cool White.

Notes for Figure 14:

1. Ao is the width of pocket and Ko is the depth of pocket. Bo is the height of pocket.
2. Drawings are not to scale.
3. All dimensions are in millimeters.

Reel Dimensions

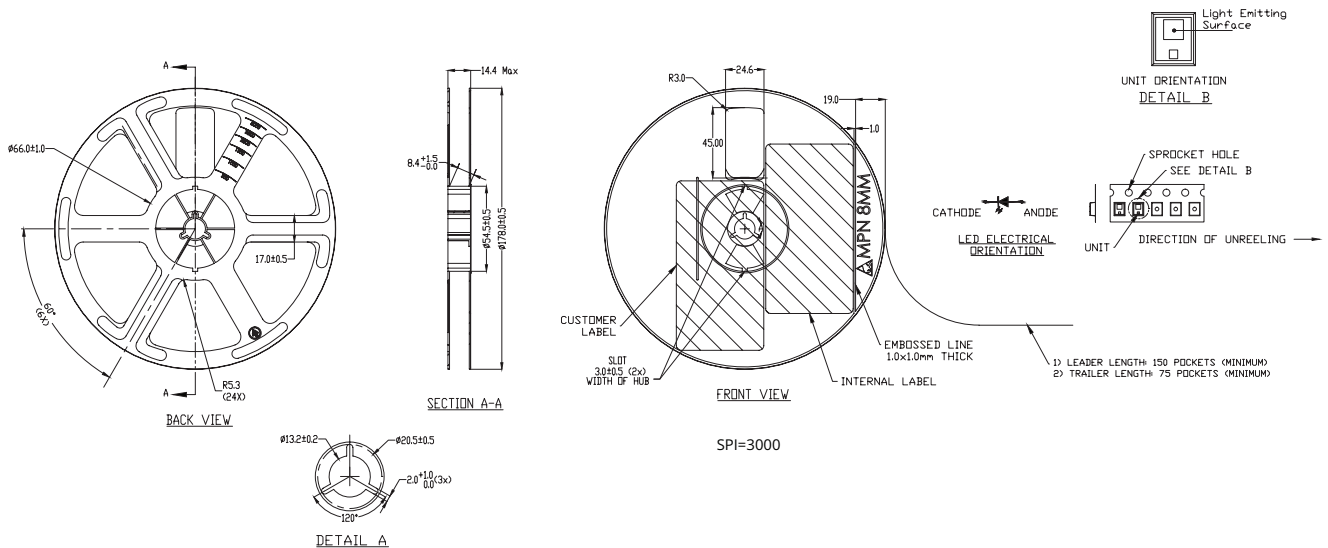

Figure 15. Reel dimensions for LUXEON F Plus Cool White.

Notes for Figure 15:

1. Drawings are not to scale.
2. All dimensions are in millimeters.
3. SPI=3,000 (SPI is the number of LEDs per reel).

About Lumileds

Companies developing automotive, mobile, IoT and illumination lighting applications need a partner who can collaborate with them to push the boundaries of light. With over 100 years of inventions and industry firsts, Lumileds is a global lighting solutions company that helps customers around the world deliver differentiated solutions to gain and maintain a competitive edge. As the inventor of Xenon technology, a pioneer in halogen lighting and the leader in high performance LEDs, Lumileds builds innovation, quality and reliability into its technology, products and every customer engagement. Together with its customers, Lumileds is making the world better, safer, more beautiful—with light.

To learn more about our lighting solutions, visit lumileds.com.



©2020 Lumileds Holding B.V. All rights reserved.
LUXEON is a registered trademark of the Lumileds Holding B.V. in the United States and other countries.
lumileds.com

Neither Lumileds Holding B.V. nor its affiliates shall be liable for any kind of loss of data or any other damages, direct, indirect or consequential, resulting from the use of the provided information and data. Although Lumileds Holding B.V. and/or its affiliates have attempted to provide the most accurate information and data, the materials and services information and data are provided "as is," and neither Lumileds Holding B.V. nor its affiliates warrants or guarantees the contents and correctness of the provided information and data. Lumileds Holding B.V. and its affiliates reserve the right to make changes without notice. You as user agree to this disclaimer and user agreement with the download or use of the provided materials, information and data. A listing of Lumileds product/patent coverage may be accessed at lumileds.com/patents.