

LUXEON F PC Amber

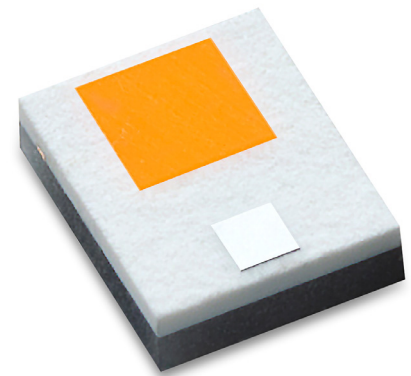

Industry-leading solutions for turn applications

LUXEON F PC Amber and LUXEON F Plus PC Amber automotive LEDs deliver design flexibility and advanced functionality. These products, with their miniaturized form factor are designed to support daytime running lights, side marker and turn signal applications. The Lumileds automotive binning structure meets both SAE and ECE color specifications and is hot binned at 85°C, consistent with actual automotive operational environments. LUXEON F PC Amber and LUXEON F Plus PC Amber provide industry-leading solutions for your front and rear turn applications. All LUXEON F LEDs are AEC-Q101 qualified.



FEATURES AND BENEFITS

- Higher drive current capability for increased flux performance
- Low thermal resistance for better hot lumen performance
- Standard packaging for low cost and ease of manufacturability
- Hot binned at 85°C mono pulse (MP) to match closer to operating conditions

PRIMARY APPLICATIONS

- Daytime Running Lights
- Side Marker
- Turn
 - Front Turn
 - Rear Turn

Table of Contents

General Product Information	2
Product Test Conditions	2
Part Number Nomenclature	2
Environmental Compliance	2
Performance Characteristics	3
Product Selection Guide	3
Optical Characteristics	3
Electrical and Thermal Characteristics	4
Absolute Ratings	4
Characteristic Curves	5
Spectral Power Distribution Characteristics	5
Light Output Characteristics	5
Forward Current Characteristics	7
Color Shift Characteristics	8
Radiation Pattern Characteristics	9
Operating Limits Characteristics	10
Permissible Pulse Handling Characteristics	10
Product Bin and Labeling Definitions	12
Designing with LUXEON F PC Amber and LUXEON F Plus PC Amber	12
Decoding Product Bin Labeling	12
Luminous Flux Bins	12
Color Bins	13
Forward Voltage Bins	14
Mechanical Dimensions	14
JEDEC Moisture Sensitivity	14
Packaging Information	15
Pocket Tape Dimensions	15
Reel Dimensions	15

General Product Information

Product Test Conditions

LUXEON F PC Amber LEDs are tested and binned using a 20ms monopulse (MP) at 350mA drive current for LUXEON F PC Amber and 1000mA for LUXEON F Plus PC Amber, case temperature, T_c , of 85°C.

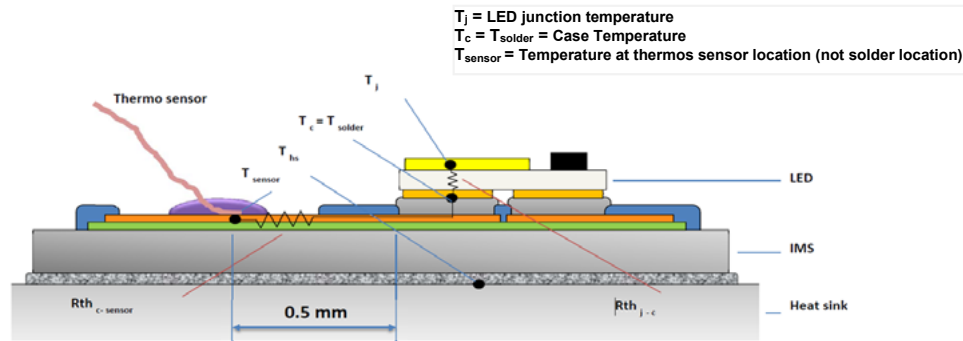

Figure 1: Example of case temperature location on sample board for LUXEON F PC Amber and LUXEON F Plus PC Amber.

Part Number Nomenclature

Part numbers for LUXEON F PC Amber and LUXEON F Plus PC Amber follow the convention below:

L F T H – A B **C** – **E F G H**

Where:

- L – designates LUXEON
- F – designates LUXEON F product family
- T H – designates hot binning
- A – designates color variant (L=PC Amber)
- B – designates die size (1=1mm²)
- C** – designates binning current (A=350mA and C=1000mA)
- E** – designates future product offerings
- F G H** – designates minimum luminous flux

Therefore, the following part number is used for a LUXEON F Plus PC Amber 1000mA with a minimum luminous flux of 150 lumens:

L F T H – L 1 **C** – 0 **1 5 0**

Environmental Compliance

Lumileds LLC is committed to providing environmentally friendly products to the solid-state lighting market. LUXEON F PC Amber and LUXEON F Plus PC Amber is compliant to the European Union directives on the restriction of hazardous substances in electronic equipment, namely the RoHS Directive 2011/65/EU and REACH Regulation (EC) 1907/2006. Lumileds LLC will not intentionally add the following restricted material to this LUXEON F: lead, mercury, cadmium, hexavalent chromium, polybrominated biphenyls (PBB) or polybrominated diphenyl ethers (PBDE).

Performance Characteristics

Product Selection Guide

Table 1. Product selection for LUXEON F PC Amber and LUXEON F Plus PC Amber at 20ms MP specified test current, $T_c=85^\circ\text{C}$.

PRODUCT	MINIMUM LUMINOUS FLUX ^[1] (lm)	TEST CURRENT (mA)	PART NUMBER
LUXEON F PC Amber	70	350	LFTH-L1A-0070
	80	350	LFTH-L1A-0080
	90	350	LFTH-L1A-0090
LUXEON F Plus PC Amber	164	1000	LFTH-L1C-0164
	174	1000	LFTH-L1C-0174
	185	1000	LFTH-L1C-0185
	196	1000	LFTH-L1C-0196
	207	1000	LFTH-L1C-0207

Notes for Table 1:

1. Lumileds maintains a tolerance of $\pm 6.5\%$ on luminous flux measurements.

Optical Characteristics

Table 2. Typical optical characteristics for LUXEON F PC Amber and LUXEON F Plus PC Amber at 20ms MP test current, $T_c=85^\circ\text{C}$.

PART NUMBER	DOMINANT WAVELENGTH (nm)		SPECTRAL HALF-WIDTH ^[1] (nm) $\Delta\lambda_{1/2}$	TEMPERATURE COEFFICIENT OF DOMINANT WAVELENGTH (nm/ $^\circ\text{C}$)	TOTAL INCLUDED ANGLE ^[2] $\theta_{0.90V}$	VIEWING ANGLE ^[3] $2\theta_{1/2}$
	MINIMUM	MAXIMUM				
LFTH-L1X-0XXX	588.8	592.6	75	0.06	164°	118°

Notes for Table 2:

1. Spectral width at $\frac{1}{2}$ of the peak intensity.
2. Total angle at which 90% of total luminous flux is captured.
3. Viewing angle is the off axis angle from the LED centerline where the luminous intensity is $\frac{1}{2}$ of the peak value.

Electrical and Thermal Characteristics

Table 3. Electrical and thermal characteristics for LUXEON F PC Amber and LUXEON F Plus PC Amber at MP specified test current, $T_c=85^\circ\text{C}$.

PART NUMBER	FORWARD VOLTAGE (V) ^[1]		DYNAMIC RESISTANCE ^[2] (Ω) R_D	TEMPERATURE COEFFICIENT OF FORWARD VOLTAGE ^[3] ($\text{mV}/^\circ\text{C}$) $\Delta V_f / \Delta T_j$	TYPICAL THERMAL RESISTANCE — JUNCTION TO CASE ($^\circ\text{C}/\text{W}$)			
	MINIMUM	MAXIMUM			$R\theta_{j-c,el}$ ^[4]		$R\theta_{j-c,real}$ ^[5]	
					TYPICAL	MAXIMUM	TYPICAL	MAXIMUM
LFTH-L1A-0XXX	2.55	3.27	0.3	-2.1	2.50	2.80	3.27	3.66
LFTH-L1C-0XXX	2.55	3.27	0.2	-2.5	2.50	2.80	3.04	3.40

Notes for Table 3:

- Lumileds maintains a tolerance of $\pm 0.06\text{V}$ on forward voltage measurements.
- Dynamic resistance is the inverse of the slope in linear forward voltage model for LEDs.
- Measured between $T_c=80^\circ\text{C}$ and $T_c=90^\circ\text{C}$ at binning current.
- $R\theta_{j-c,el}$: Electrical thermal resistance (junction to case).
- $R\theta_{j-c,real}$: Real thermal resistance (junction to case) with wall plug efficiency included. Reference JESD51-51, JESD51-14, 4.1.3.

Absolute Ratings

Table 4. Absolute ratings for LUXEON F PC Amber and LUXEON F Plus PC Amber.

PARAMETER	PERFORMANCE
Minimum DC Forward Current	50mA
Maximum DC Forward Current	700mA for LUXEON F PC Amber 1000mA for LUXEON F Plus PC Amber
Maximum Junction Temperature ^[1]	135°C
Operating Case Temperature at Test Current ^[1]	-40°C to 125°C
Operating Case Temperature at Maximum Current ^[1]	-40°C to 125°C
Storage Temperature	-40°C to 130°C
Maximum Soldering Temperature	260°C
Allowable Reflow Cycles	3
ESD Sensitivity ^[2]	$\pm 8\text{ kV HBM}$, $\pm 400\text{ V MM}$, $\pm 2\text{ kV CDM}$
Reverse Voltage (V_r)	LUXEON F LEDs are not designed to be driven in reverse bias
Autoclave Conditions	121°C at 2 ATM 100% Relative Humidity for 96 Hours Maximum

Notes for Table 4:

- Proper current derating must be used to maintain junction temperature below the maximum. LUXEON F LEDs driven at or above the maximum LED case temperature may have shorter lifetime.
- Measured using human body model (per JESD22 A114), machine model (per JESD22 A115) and charged device model (per JESD22 C101).

Characteristic Curves

Spectral Power Distribution Characteristics

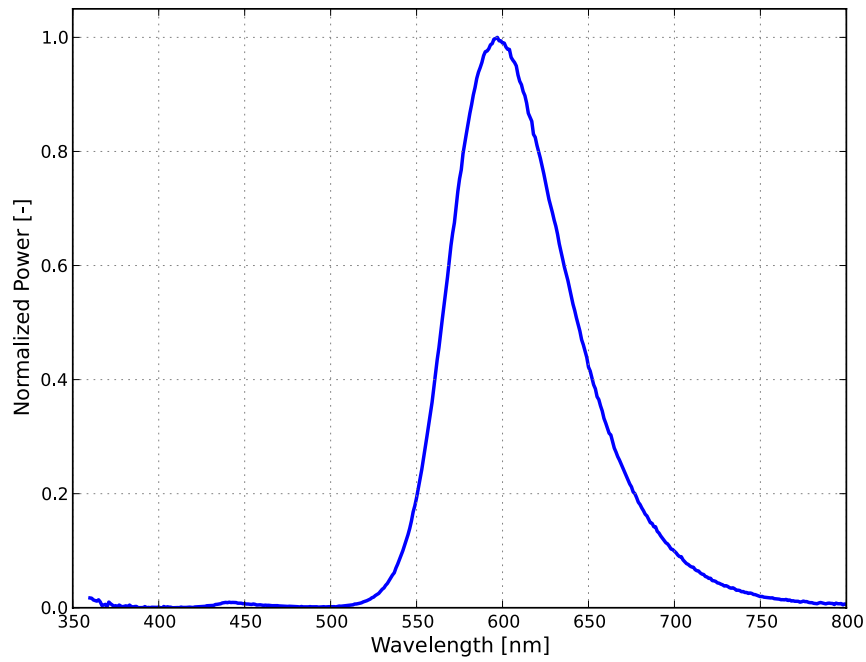

Figure 2: Typical normalized power vs. wavelength for LUXEON F PC Amber and LUXEON F Plus PC Amber at test current, $T_c=85^\circ\text{C}$.

Light Output Characteristics

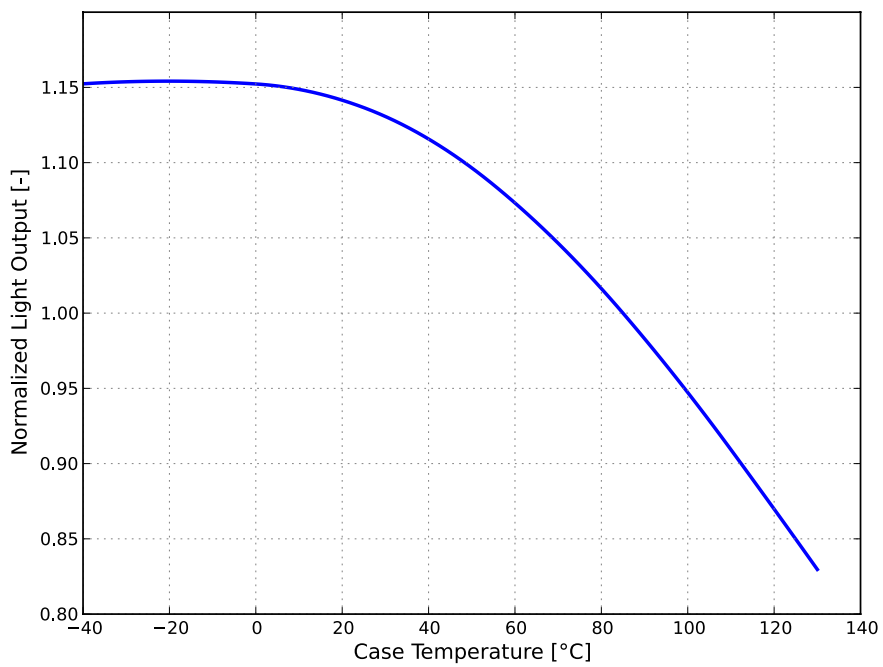

Figure 3a: Typical normalized light output vs. case temperature for LUXEON F PC Amber at 20ms MP, 350mA.

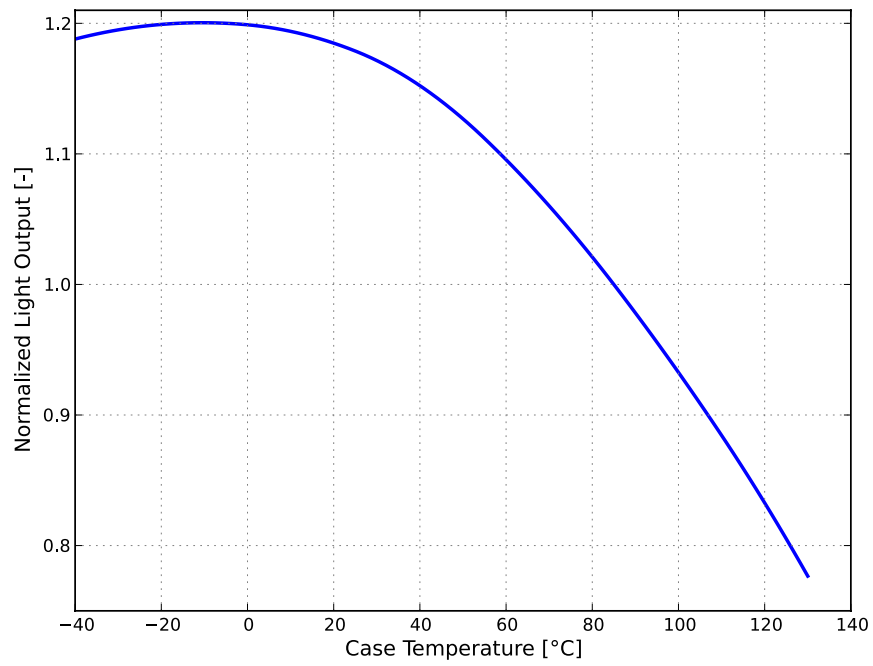

Figure 3b: Typical normalized light output vs. case temperature for LUXEON F Plus PC Amber at 20ms MP, 1000mA.

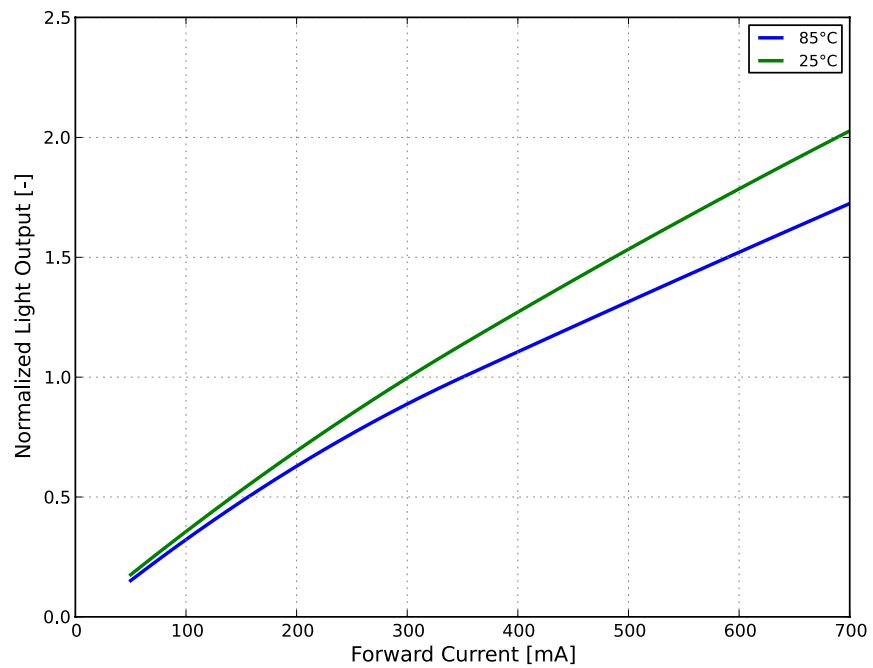

Figure 4a: Typical normalized light output vs. forward current for LUXEON F PC Amber.

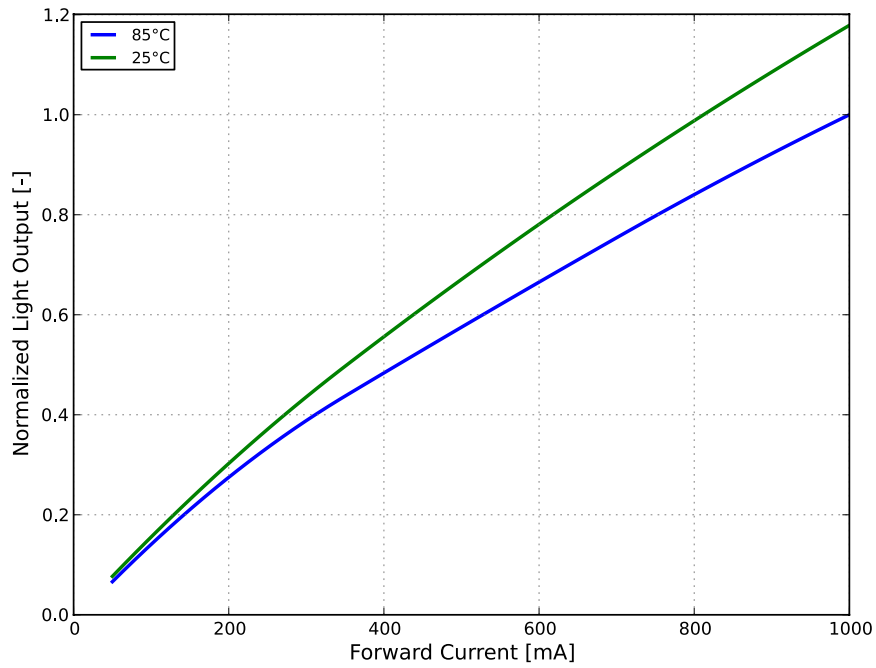

Figure 4b: Typical normalized light output vs. forward current for LUXEON F Plus PC Amber.

Forward Current Characteristics

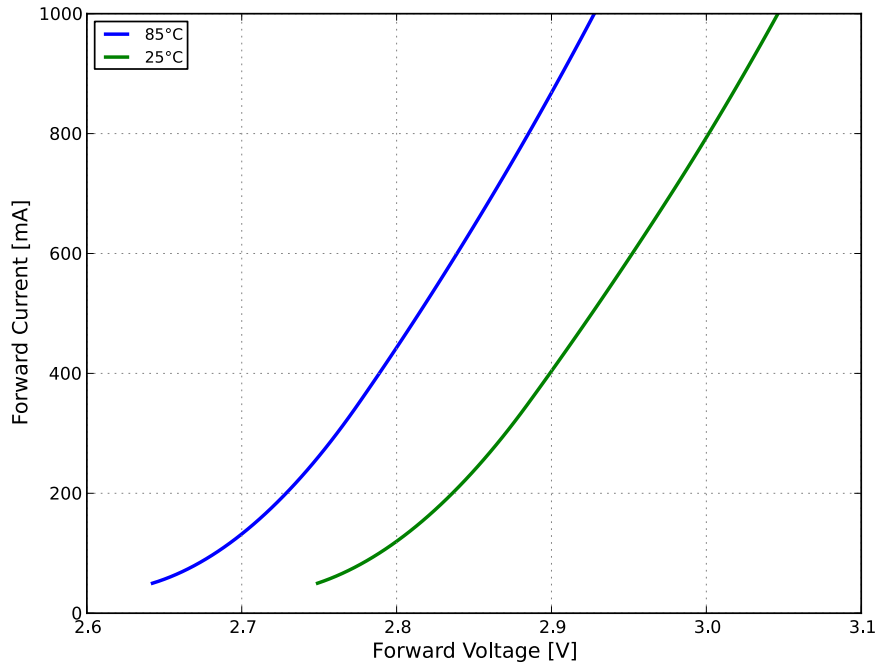

Figure 5: Typical forward current vs. forward voltage for LUXEON F PC Amber and LUXEON F Plus PC Amber at 20ms MP at specified test temperature.

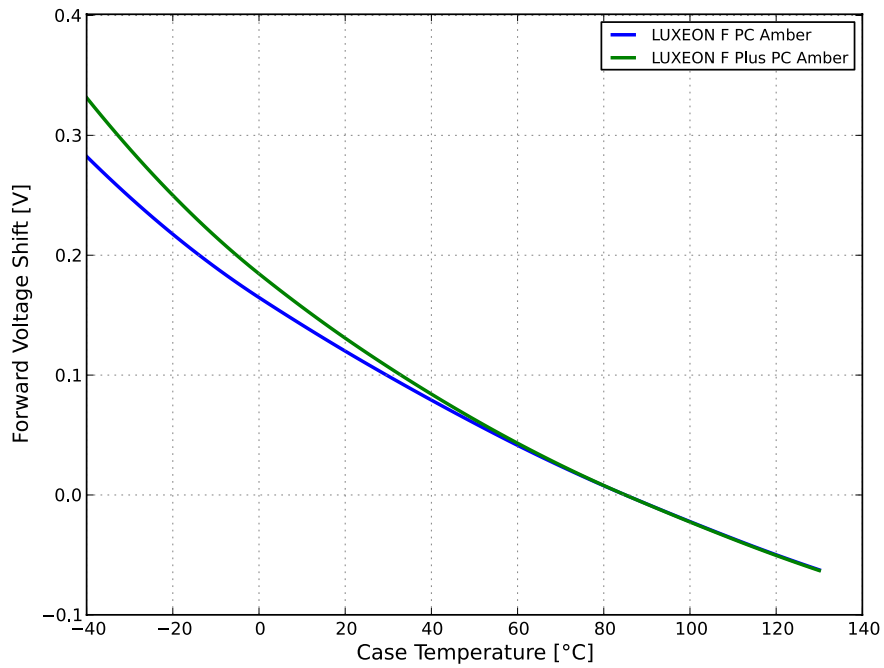

Figure 6: Typical forward voltage shift vs. case temperature for LUXEON F PC Amber and LUXEON F Plus PC Amber at 20ms MP, specified test current.

Color Shift Characteristics

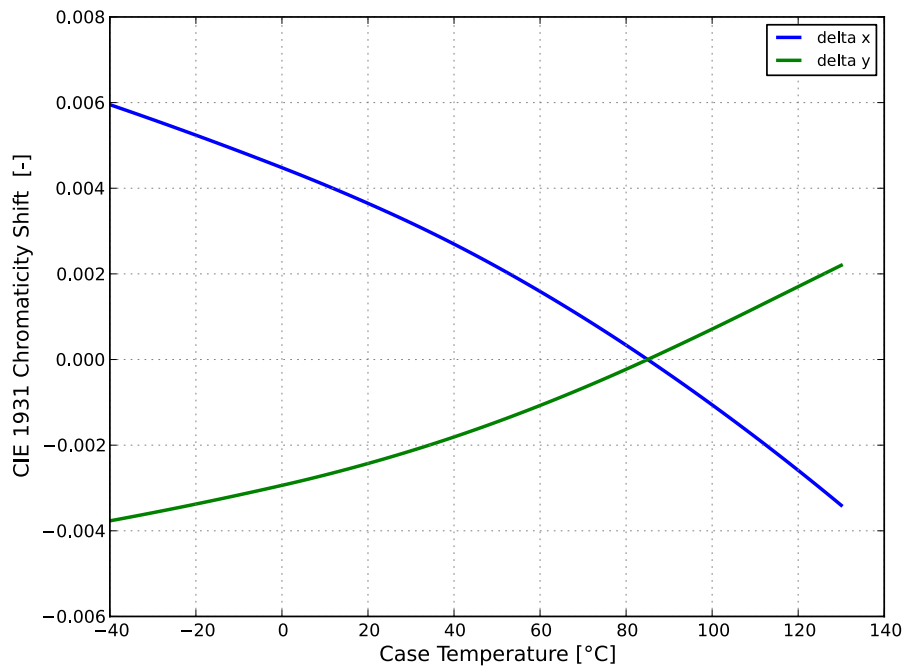

Figure 7a. Typical color shift in CIE 1931 x, y coordinates for LUXEON F PC Amber at 20ms MP, 350mA.

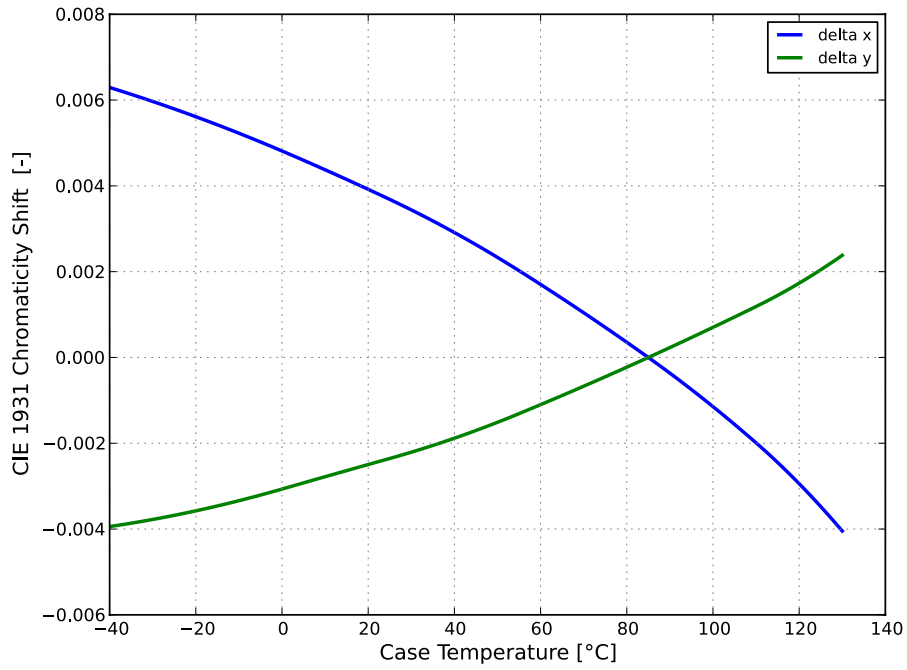

Figure 7b. Typical color shift in CIE1931 x,y coordinates for LUXEON F Plus PC Amber at 20ms MP, 1000mA.

Radiation Pattern Characteristics

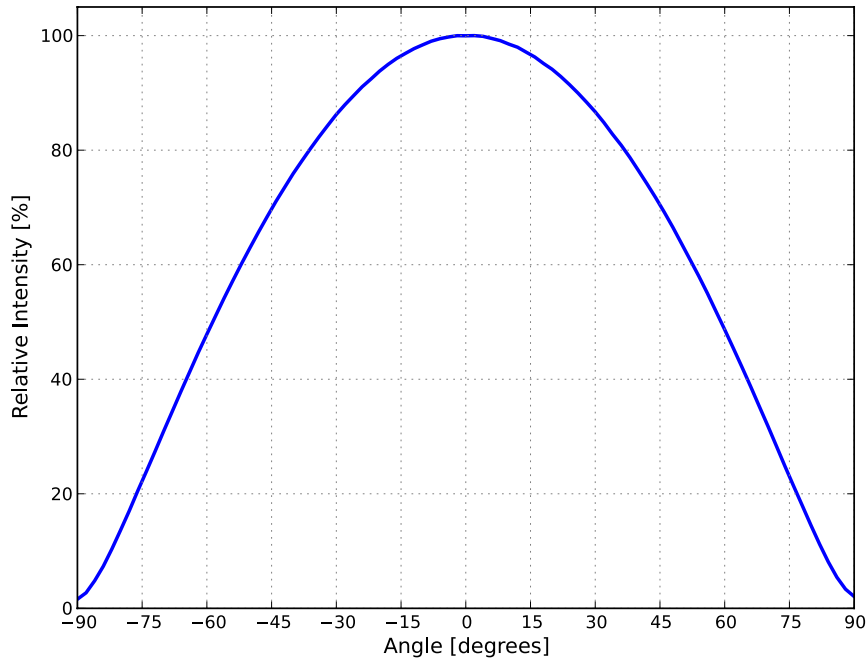

Figure 8: Typical radiation pattern for LUXEON F PC Amber and LUXEON F Plus PC Amber at 20ms MP specified test current, $T_c=85^\circ\text{C}$.

Operating Limits Characteristics

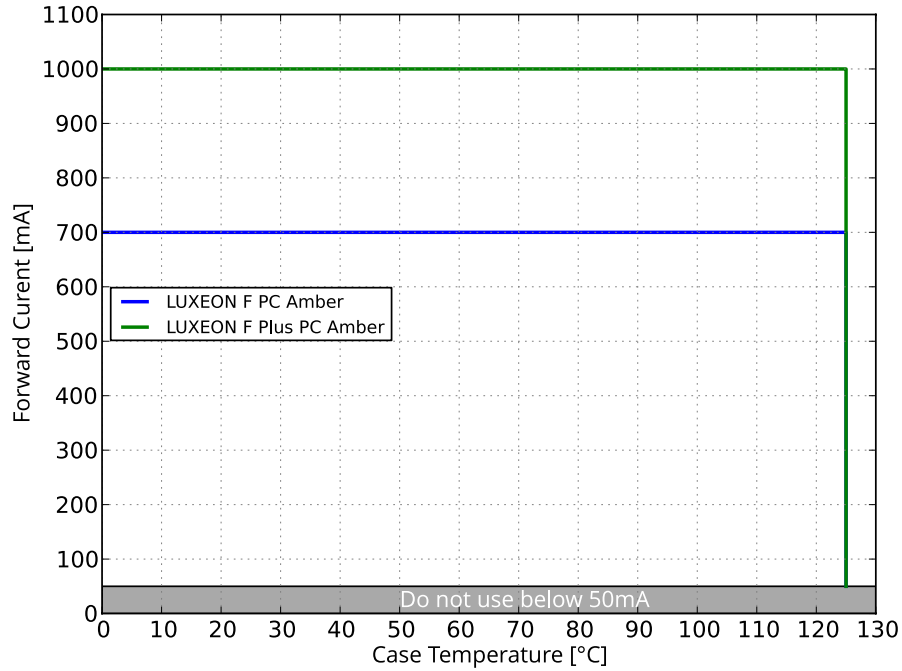

Figure 9: Maximum forward current vs. case temperature for LUXEON F PC Amber and LUXEON F Plus PC Amber.

Permissible Pulse Handling Characteristics

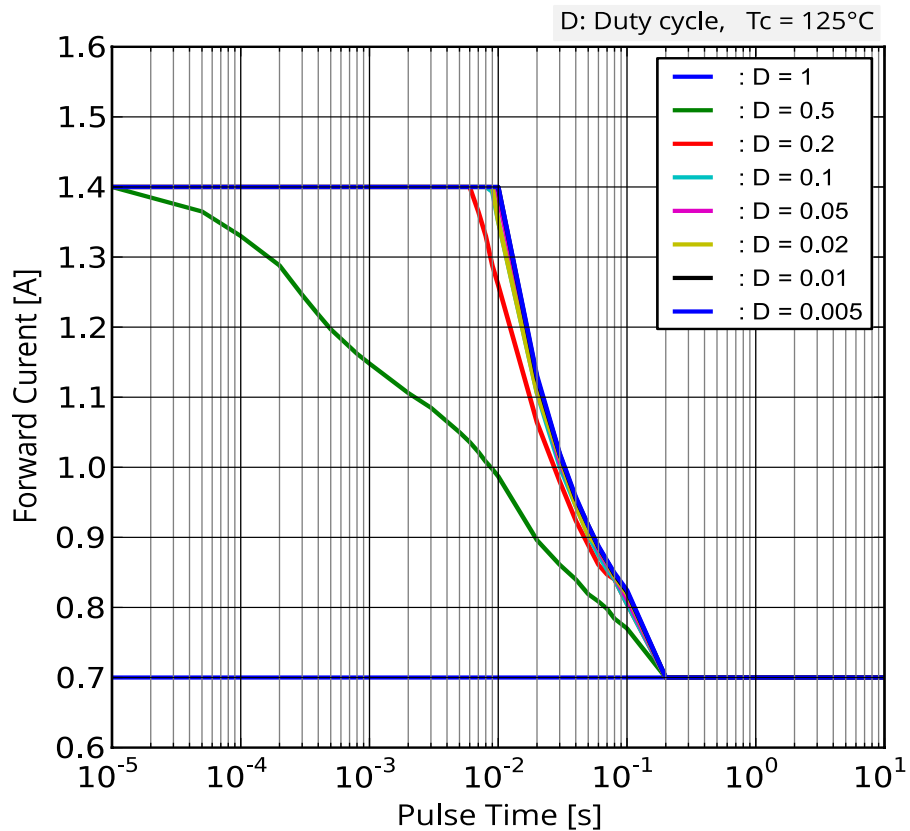

Figure 10a: Permissible pulse handling capability for LUXEON F PC Amber.

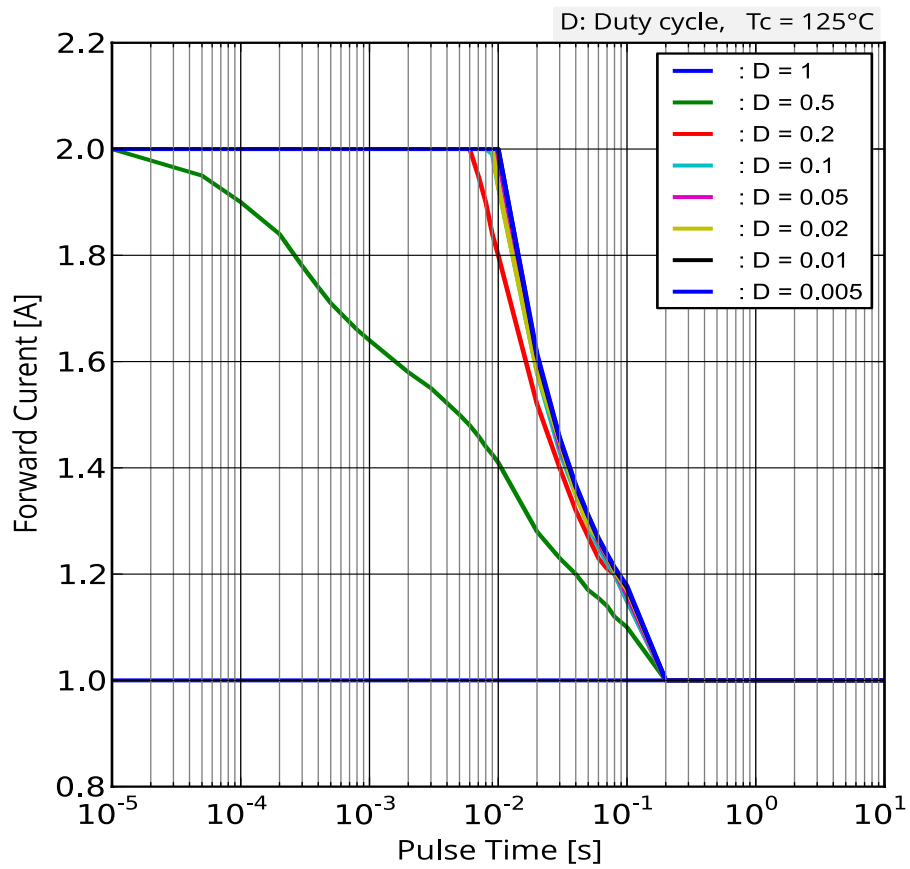

Figure 10b: Permissible pulse handling capability for LUXEON F Plus PC Amber.

Product Bin and Labeling Definitions

Designing with LUXEON F PC Amber and LUXEON F Plus PC Amber

Flux bins supportable for car programs depend on product color and program start- and end-of-production date. Flux roadmaps by year and product color are maintained and available from the sales representative. Please contact your local sales representative to request the flux bin range with best supportability for program timing.

Decoding Product Bin Labeling

In the manufacturing of semiconductor products, there are variations in performance around the average values given in the technical datasheets. For this reason, Lumileds bins the LED components for luminous flux, color and forward voltage.

LUXEON F PC Amber and LUXEON F Plus PC Amber are labeled using a 3-digit alphanumeric CAT code following the format below.

A B C

Where:

- A** – designates luminous flux bin (example: D=70 lumens to 80 lumens)
- B** – designates color bin (example: A or B)
- C** – designates forward voltage bin (example: B=2.55V to 2.79V)

Therefore, a LUXEON F PC Amber with a lumen range of 70 to 80, color bin of A and a forward voltage range of 2.55 to 2.79V has the following CAT code:

D A B

Luminous Flux Bins

Table 5 lists the standard luminous flux bins for LUXEON F PC Amber and LUXEON F Plus PC Amber emitters. Product availability in a particular bin varies by color and platform start of production date. Contact local sales representative for best supportability of programs.

Table 5a. Luminous flux bin definitions for LUXEON F PC Amber at 20ms MP specified test current, $T_c=85^\circ\text{C}$.

BIN	LUMINOUS FLUX (lm) ^[1]	
	MINIMUM	MAXIMUM
D	70	80
E	80	90
F	90	100
G	100	110
H	110	120
J	120	130

Notes for Table 5a:

1. Lumileds maintains a tolerance of $\pm 6.5\%$ on luminous flux measurements.

Table 5b. Luminous flux bin definitions for LUXEON F Plus PC Amber at 20ms MP specified test current, $T_c=85^\circ\text{C}$.

BIN	LUMINOUS FLUX (lm) ^[1]	
	MINIMUM	MAXIMUM
L	153	164
M	164	174
N	174	185
P	185	196
Q	196	207
R	207	218
S	218	240

Notes for Table 5b:

1. Lumileds maintains a tolerance of $\pm 6.5\%$ on luminous flux measurements.

Color Bins

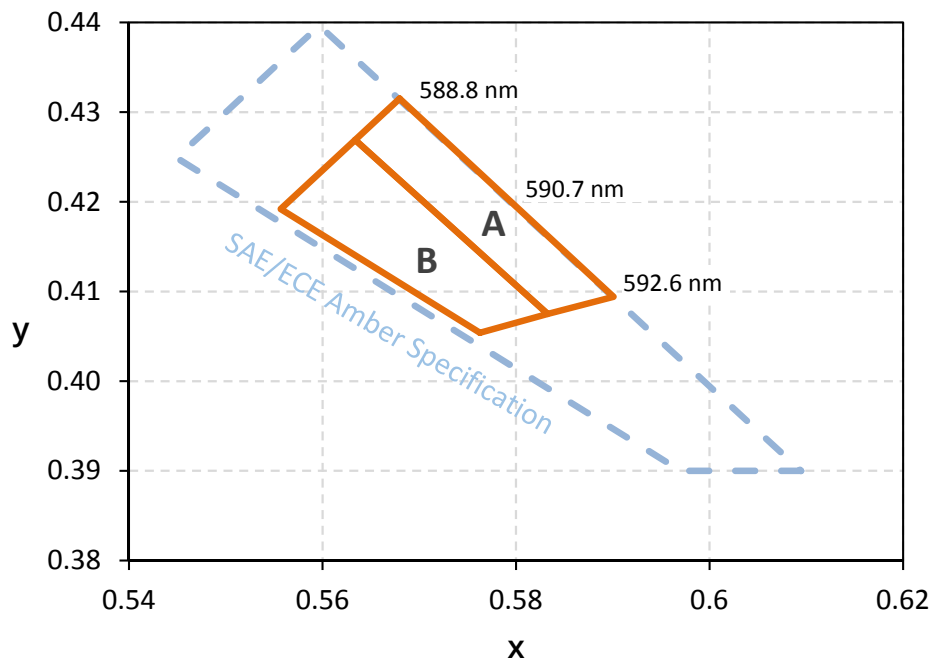

Figure 11. Color bin structure in CIE 1931 color space for LUXEON F PC Amber and LUXEON F Plus PC Amber.

Table 6. Color bin definitions for LUXEON F PC Amber and LUXEON F Plus PC Amber at 20ms MP specified test current.

BIN	x	y
A	0.5680	0.4315
	0.5634	0.4269
	0.5833	0.4075
	0.5901	0.4094
B	0.5763	0.4054
	0.5833	0.4075
	0.5634	0.4269
	0.5557	0.4192

Notes for Table 6:

1. Lumileds maintains a tolerance of ± 0.005 on x and y coordinates in the CIE 1931 color space.

Forward Voltage Bins

Table 7. Forward voltage bin definitions for LUXEON F PC Amber and LUXEON F Plus PC Amber.

BIN ^[1]	FORWARD VOLTAGE ^[2] (V)	
	MINIMUM	MAXIMUM
B	2.55	2.79
C	2.79	3.03
D	3.03	3.27

Notes for Table 7:

1. Although several bins are outlined, product availability in a particular bin varies by production run and by product performance.
2. Lumileds maintains a tolerance of $\pm 0.06V$ on forward voltage measurements.

Mechanical Dimensions

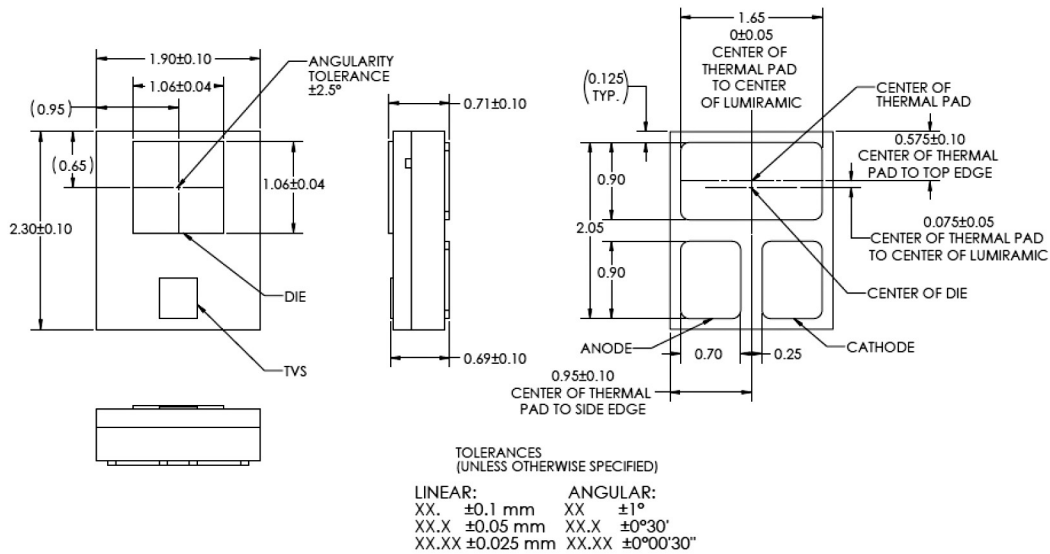

Figure 12: Mechanical dimensions for LUXEON F PC Amber and LUXEON F Plus PC Amber.

Notes for Figure 12:

1. Drawings are not to scale.
2. All dimensions are in millimeters.

JEDEC Moisture Sensitivity

Table 8. Moisture sensitivity levels for LUXEON F PC Amber and LUXEON F Plus PC Amber.

LEVEL	FLOOR LIFE		SOAK REQUIREMENTS STANDARD	
	TIME	CONDITIONS	TIME	CONDITIONS
1	Unlimited	$\leq 30^\circ C / 85\% RH$	168 Hours +5 / -0	$85^\circ C / 85\% RH$

Packaging Information

Pocket Tape Dimensions

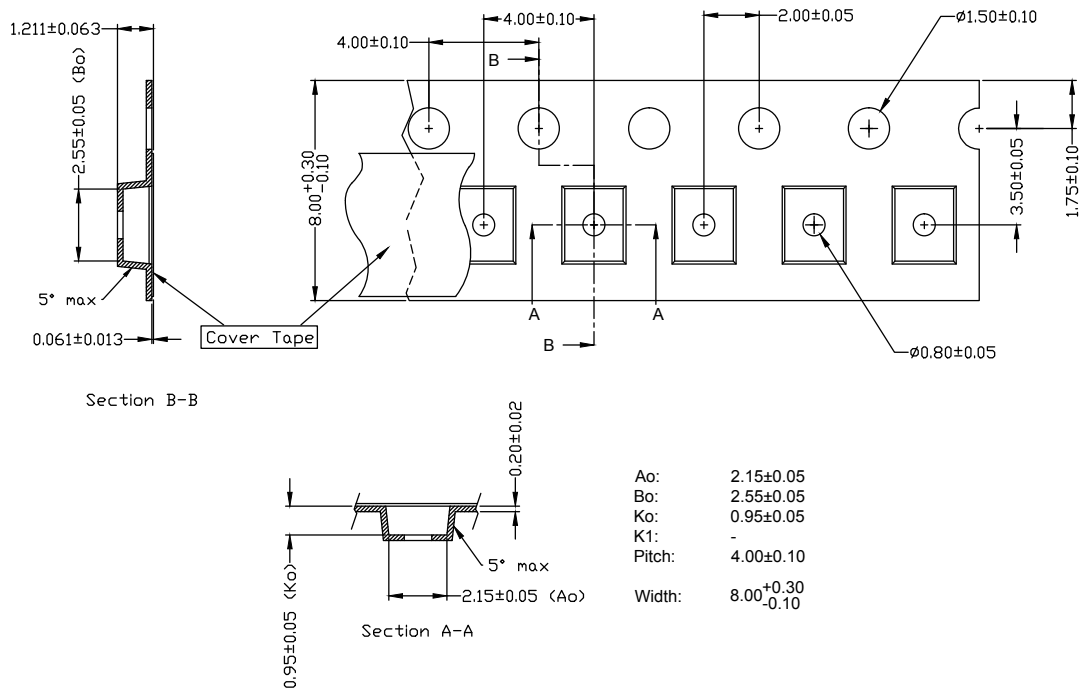

Figure 13: Pocket tape dimensions for LUXEON F PC Amber and LUXEON F Plus PC Amber.

Notes for Figure 13:

1. Drawings are not to scale.
2. All dimensions are in millimeters.
3. A_o is the width of pocket. K_o is the depth of pocket. B_o is the height of pocket.

Reel Dimensions

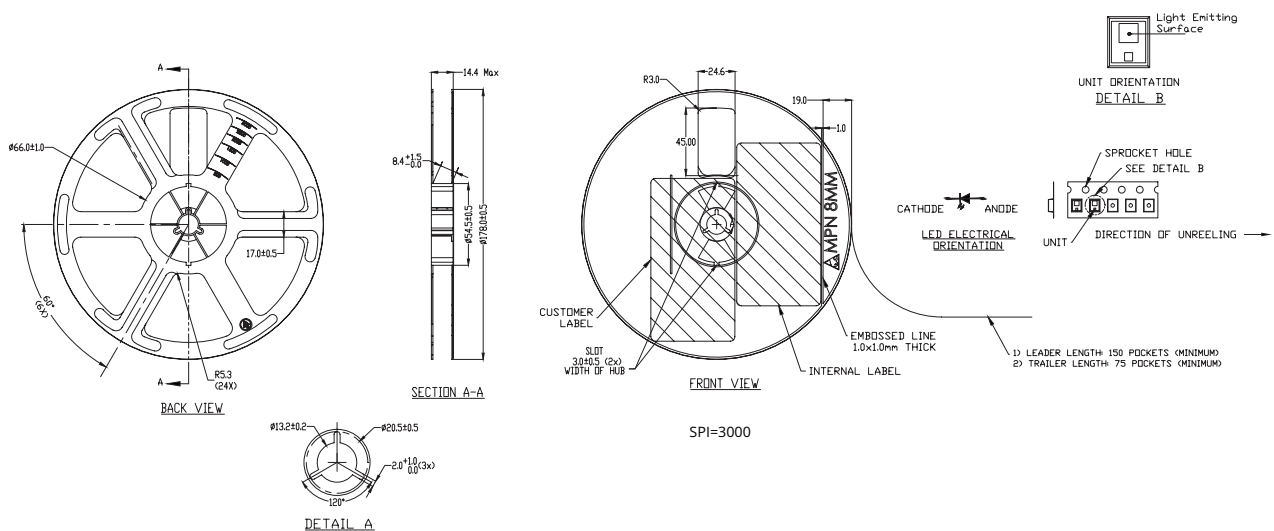

Figure 14: Reel dimensions for LUXEON F PC Amber and LUXEON F Plus PC Amber.

Notes for Figure 14:

1. Drawings are not to scale.
2. All dimensions are in millimeters.
3. SPI=3,000 (SPI is the number of LEDs per reel).

About Lumileds

Companies developing automotive, mobile, IoT and illumination lighting applications need a partner who can collaborate with them to push the boundaries of light. With over 100 years of inventions and industry firsts, Lumileds is a global lighting solutions company that helps customers around the world deliver differentiated solutions to gain and maintain a competitive edge. As the inventor of Xenon technology, a pioneer in halogen lighting and the leader in high performance LEDs, Lumileds builds innovation, quality and reliability into its technology, products and every customer engagement. Together with its customers, Lumileds is making the world safer, better and more beautiful—with light.

To learn more about our lighting solutions, visit lumileds.com.



©2017 Lumileds Holding B.V. All rights reserved.
LUXEON is a registered trademark of the Lumileds Holding B.V. in the United States and other countries.
lumileds.com

Neither Lumileds Holding B.V. nor its affiliates shall be liable for any kind of loss of data or any other damages, direct, indirect or consequential, resulting from the use of the provided information and data. Although Lumileds Holding B.V. and/or its affiliates have attempted to provide the most accurate information and data, the materials and services information and data are provided "as is," and neither Lumileds Holding B.V. nor its affiliates warrants or guarantees the contents and correctness of the provided information and data. Lumileds Holding B.V. and its affiliates reserve the right to make changes without notice. You as user agree to this disclaimer and user agreement with the download or use of the provided materials, information and data. A listing of Lumileds product/patent coverage may be accessed at lumileds.com/patents.